

LTM 1400NX

リープヘル製
オールテレーンクレーン
吊上荷重400ton

Technical Data

メインブーム
70m

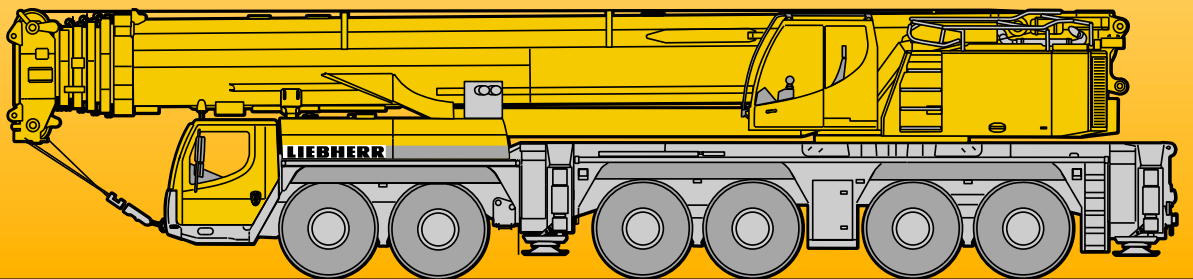

LIEBHERR

クレーン部主仕様

吊上荷重	400ton×2.5m	
メインブーム長さ	14.9～70m	
補助ジブ	固定式	6～42m
	起伏式	12～78m
メインブーム段数	6段	
カウンタウエイト	140/100ton	
第1ウインチ	ラインプル	12.4ton
	巻上速度	0-120m/分
	ワイヤー長さ/径	350m/23mm
第2ウインチ	ラインプル	12.4ton
	巻上速度	0-120m/分
	ワイヤー長さ/径	700m/23mm
最大地上揚程	メインブーム	70m/14ton
	補助ジブ	102m/3.9ton
巡回速度	0-1.2rpm	
起伏速度 (84度まで)	約75秒	
ブーム伸縮速度 (14.9～70m)	約533秒	

フック仕様

容量 (ton)	シーブ数
200	9
160	7
125	5
80	3
37	1
12.5	—

フックはオプション設定
ですので左記の中からお
選びください。

エンジン仕様

メーカー名	リープヘル社製
型式	D934LA6 ディーゼル
冷却方式	水冷
シリンダー数	4
出力	245HP 1800rpm
最大トルク	116kg-m 1500rpm
燃料タンク	400ℓ

特徴

■ コントロール

ジョイスティックタイプの操作レバー（自動復帰式のユニバーサルコントロール）により電気式パイロットコントロールされます。

■ 油圧駆動装置

ウインチ回路には圧力補償付流量調整弁を有し、また、自動出力調整装置付油圧ポンプにより駆動されます。

■ 安全装置および指示計

LICCON（リーコン） 過負荷防止計が装備され、吊上げ総荷重、作業半径、ブーム長さ、揚程及びアウトリガ反力等がデジタルで表示されます。

過巻防止装置、ドラム回転計、過巻出し防止装置、油圧安全弁、油圧システム保護用安全バルブが装備されています。

キャビンが20度までチルトバックします。

本機は、公道を走行する場合、メインブームを別送として走行しなければなりません。



キャリア部主仕様

軸数	6
最高速度	80km/h
総輪数	12
定員	2名
タイヤ	16.00 R25
登坂能力* (低速切換時)	約26.9°
最小回転半径	11.98m

*登坂時の路面状況により、能力も多少異なります。

エンジン仕様

メーカー名	リープヘル社製
型式	D9508A7 ディーゼル・エンジン
冷却方式	水冷
シリンダー数	8
出力	612HP 1900rpm
最大トルク	291kg-m 1500rpm
燃料タンク	約550 ℓ

特徴

■ トランスミッション

ZF製で、トルクコンバーター及びインターダーを内蔵しております。前進12段、後進2段となっており、“TC-TRONIC”自動制御システムを採用しています。

■ サスペンション

全軸ハイドロニューマチックサスペンションであり、自動水平復帰機能（ニポー）を有しています。状況に応じて車高を上下に調整可能です。全軸油圧サスペンションをロックすることが可能です。

■ ステアリング

油圧源として1つは通常時、エンジンで駆動され、もう1つは非常用として駆動軸により駆動されます。



■ 常用ブレーキ

2回路式サーボブレーキが全軸に装備されています。また、エディカレント式電磁ブレーキ（オプション）を装備しています。

■ パーキング用ブレーキ

スプリング作動のブレーキが第2～6軸に作動します。

走行速度

	1	2	3	4	5	6	7	8	9	10	11	12	R ₁	R ₂	
															
(km/h)	245-62	7.9	10.3	13.1	16.7	21.4	28.2	36.2	46.8	60	76.1	80	264-67	8.6	50.9%

走行軌跡図

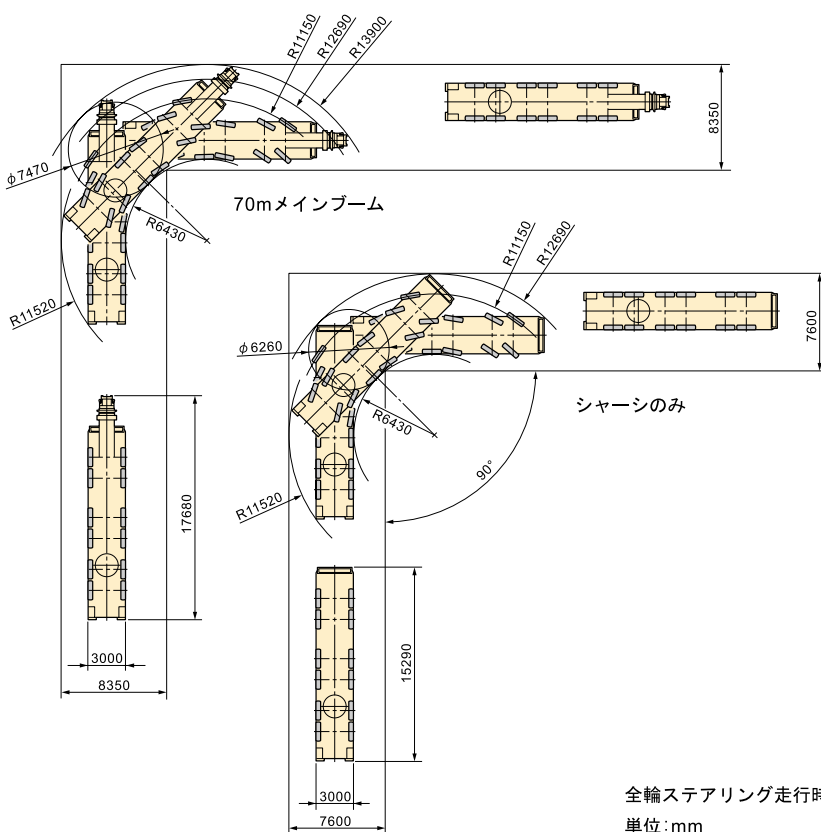

全輪ステアリング走行時
単位:mm

駆動部

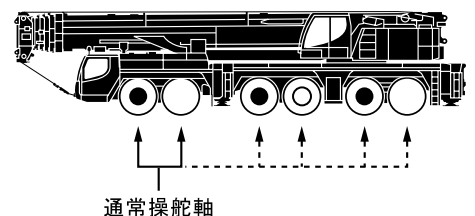

● 駆動軸：常時駆動します。

○：追加駆動軸

第3～6軸は第1～2軸と独立して操舵可能。（リアステアリング操作）

30km/h以下：1、2軸及び3～6軸が電氣的に操舵。

30km/h以上：3、4軸が直進に固定。
60km/h以上：さらに5、6軸が直進に固定。

ただし、状況により1～3軸が同方向、4～6軸が反対方向に操舵も可能。

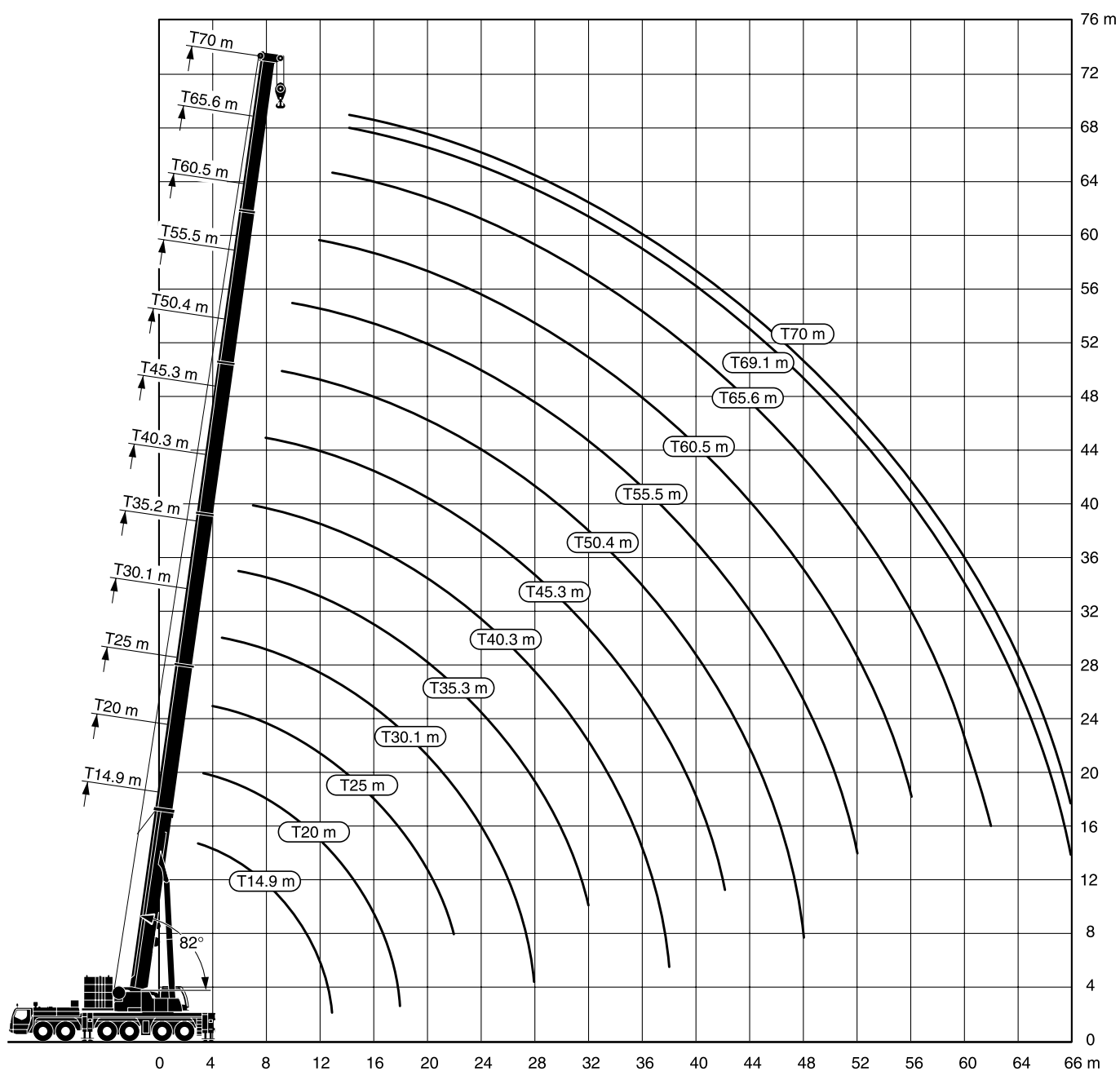

注意

- 1 定格総荷重はフックブロック、玉掛ワイヤー等の自重を含みます。
また、下記の条件が考慮されていないのでクレーンの操作には充分気をつけてください。
 - ① 地盤の強度、地震による影響
 - ② 作業速度に応じた動荷重および台風または強風による影響等
- 2 本機は水平に設置して、クレーン作業を行ってください。
- 3 作業半径は、クレーンの旋回中心から荷重の重心までの水平距離です。
- 4 メインブームの定格総荷重は補助ジブを取り除いた状態での値です。
- 5 メインブーム70m仕様で200トンを超える定格総荷重の場合は、特殊吊装置が必要です。

メインブーム定格総荷重表 T

LTM 1400NX

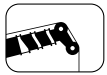

14.9m-70m



8.9m×8.53m



360°

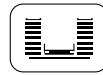

140t

作業半径(m)	メインブーム長さ	14.9m	20m	25m	30.1m	35.2m	40.3m	45.3m	50.4m	55.5m	60.5m	65.6m	69.1m	70m
2.5	400.0													
3	350.0													
3.5	210.1													
4	198.0													
4.5	182.0													
5	170.0													
6	152.6	141.5	141.5											
7	132.0	126.3	127.1	121.1	110.8	80.1								
8	115.2	113.8	114.6	111.3	105.7	90.3	66.1							
9	102.0	103.4	104.3	103.1	97.5	88.9	70.8	54.5	43.2					
10	91.3	94.7	95.4	94.7	90.8	86.9	70.8	52.2	42.4	33.9				
11	82.4	87.1	87.9	87.1	85.1	82.0	70.1	49.7	41.1	33.5				
12	75.0	79.7	81.3	80.5	79.8	77.2	68.1	47.0	39.4	32.9	27.3			
13	51.8	51.8	75.7	74.8	74.4	72.9	65.6	44.6	37.7	31.8	26.9	21.9		
14			70.6	69.7	69.3	68.9	62.6	42.2	36.0	30.7	26.3	21.7	18.3	17.7
16			61.6	61.2	60.7	61.5	56.6	38.0	32.9	28.3	24.7	21.1	17.7	17.2
18			36.7	53.8	53.7	54.1	51.6	34.0	30.1	26.1	23.0	20.1	16.8	16.5
20				47.6	48.4	47.8	47.2	31.5	27.4	24.2	21.4	19.1	15.9	15.6
22				38.4	43.3	42.7	43.4	29.2	25.0	22.3	20.0	18.0	15.0	14.8
24					39.1	38.4	39.3	27.5	22.9	20.6	18.6	16.9	14.1	14.0
26					33.5	34.7	35.6	25.8	21.0	19.1	17.3	15.9	13.3	13.2
28					21.5	31.6	32.5	24.3	19.4	17.6	16.1	14.9	12.6	12.5
30						29.1	29.8	23.1	17.9	16.3	15.0	13.9	11.8	11.7
32						23.0	27.4	21.9	17.0	15.1	14.0	13.1	11.1	11.0
34							25.1	20.9	16.1	14.0	13.0	12.2	10.5	10.4
36							20.7	20.0	15.3	13.1	12.1	11.5	9.8	9.7
38							14.0	19.2	14.6	12.3	11.3	10.8	9.2	9.1
40								18.5	13.8	11.6	10.7	10.1	8.7	8.5
42								14.7	13.2	11.1	10.1	9.5	8.2	7.9
44									12.7	10.5	9.5	8.9	7.7	7.4
46									12.2	10.1	9.0	8.3	7.3	6.9
48									8.9	9.6	8.5	7.8	6.9	6.5
50										9.3	8.1	7.3	6.5	6.0
52										8.9	7.7	6.9	6.1	5.6
54											7.3	6.4	5.8	5.2
56											7.0	6.0	5.5	4.9
58											5.6	5.7	5.2	4.5
60												5.3	4.9	4.2
62												4.9	4.7	3.9
64													4.4	3.7
66													4.1	3.4

*後方吊、カウンターウエイト100t

50301

メインブーム定格総荷重表 T

LTM 1400NX

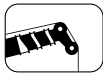

14.9m—70m

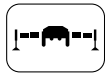

8.9m×8.53m

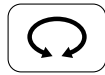

360°



100t

メインブーム 長さ 作業半径(m)	14.9m	20m	25m	30.1m	35.2m	40.3m	45.3m	50.4m	55.5m	60.5m	65.6m	69.1m	70m		
3	155.7														
3.5	155.7	155.7													
4	155.7	155.7	155.2												
4.5	155.7	155.7	154.8	114.6											
5	155.1	154.7	146.8	114.6											
6	137.2	137.9	133.3	114.6	93.0										
7	122.4	123.2	121.1	111.2	91.6	70.8									
8	110.2	111.1	110.3	105.7	90.3	70.8	55.7								
9	100.2	101.0	100.3	97.5	88.9	70.8	54.5	43.2							
10	91.3	92.2	91.2	90.2	86.9	70.8	52.2	42.4	33.9						
11	82.4	83.3	82.5	82.2	82.0	70.1	49.7	41.1	33.5						
12	75.0	75.9	75.1	75.8	75.6	68.1	47.0	39.4	32.9	27.3					
13	51.8	69.7	68.8	69.8	69.2	65.6	44.6	37.7	31.8	26.9	21.9				
14		64.2	64.3	64.3	63.7	62.6	42.2	36.0	30.7	26.3	21.7	18.3	17.7		
16		55.2	55.5	55.3	54.7	55.7	38.0	32.9	28.3	24.7	21.1	17.7	17.2		
18		36.7	48.5	48.3	47.7	48.7	34.0	30.1	26.1	23.0	20.1	16.8	16.5		
20			42.9	42.7	42.9	43.0	31.5	27.4	24.2	21.4	19.1	15.9	15.6		
22			37.9	38.0	39.0	38.3	29.2	25.0	22.3	20.0	18.0	15.0	14.8		
24				33.8	34.9	34.1	27.5	22.9	20.6	18.6	16.9	14.1	14.0		
26				31.3	31.2	30.4	25.8	21.0	19.1	17.3	15.9	13.3	13.2		
28				21.5	28.1	27.3	24.3	19.4	17.6	16.1	14.9	12.6	12.5		
30					25.5	24.7	23.1	17.9	16.3	15.0	13.9	11.8	11.7		
32					22.5	22.4	21.9	17.0	15.1	14.0	13.1	11.1	11.0		
34						20.4	20.8	16.1	14.0	13.0	12.2	10.5	10.4		
36							18.7	19.4	15.3	13.1	12.1	11.5	9.8	9.7	
38							14.0	17.8	14.6	12.3	11.3	10.8	9.2	9.1	
40								16.4	13.8	11.6	10.7	10.1	8.7	8.5	
42									14.6	13.2	11.1	10.1	9.5	8.2	7.9
44										12.7	10.5	9.5	8.9	7.7	7.4
46										12.2	10.1	9.0	8.3	7.3	6.9
48										8.9	9.6	8.5	7.8	6.9	6.5
50											9.3	8.1	7.3	6.5	6.0
52											8.9	7.7	6.9	6.1	5.6
54												7.3	6.4	5.8	5.2
56												7.0	6.0	5.5	4.9
58												5.6	5.7	5.2	4.5
60													5.3	4.9	4.2
62													4.9	4.7	3.9
64														4.4	3.7
66														4.1	3.4

50305

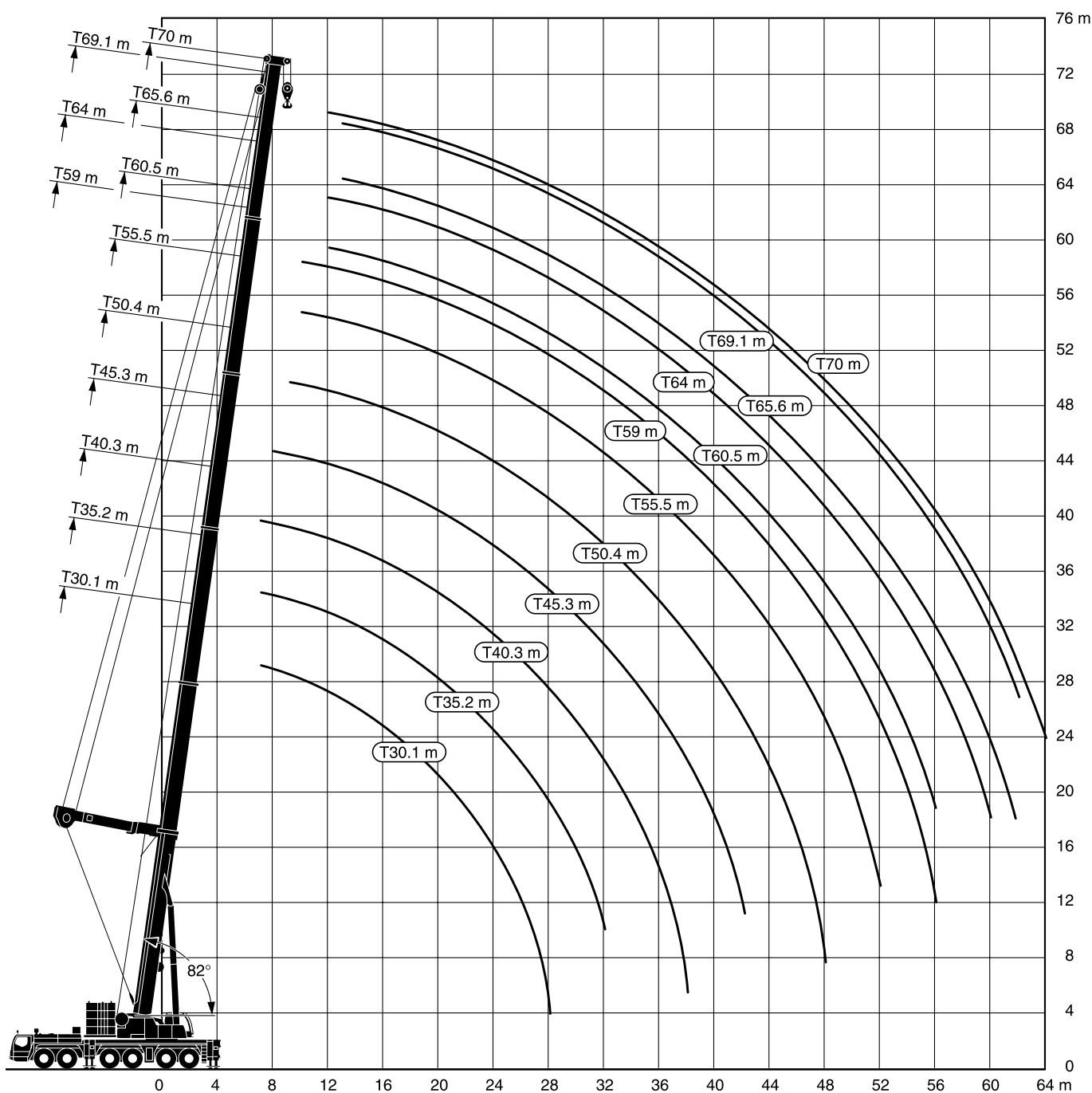

注意

- 1 定格総荷重はフックブロック、玉掛ワイヤー等の自重を含みます。
また、下記の条件が考慮されていませんのでクレーンの操作には充分気をつけてください。
 - ① 地盤の強度、地震による影響
 - ② 作業速度に応じた動荷重および台風または強風による影響等
- 2 本機は水平に設置して、クレーン作業を行ってください。
- 3 作業半径は、クレーンの旋回中心から荷重の重心までの水平距離です。
- 4 メインブームの定格総荷重は補助ジブを取り除いた状態での値です。
- 5 メインブーム70m仕様で200トンを超える定格総荷重の場合は、特殊吊装置が必要です。

メインブーム(ガイ仕様) 定格総荷重表 TY

LTM 1400NX

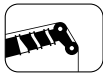

30.1m-70m

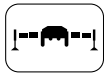

8.9m×8.53m



360°

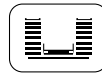

140t



メインブーム 長さ 作業半径(m)	30.1m	35.2m	40.3m	45.3m	50.4m	55.5m	59m	60.5m	64m	65.6m	69.1m	70m
8	106.8	98.5										
9	99.6	94.9	84.6									
10	92.4	89.2	83.2	75.5								
11	87.1	83.5	78.6	73.9								
12	80.7	78.6	74.9	71.0	65.4							
13	74.7	74.0	70.7	67.6	63.0	56.4	51.2	48.1		42.6		36.4
14	69.4	69.7	67.4	64.3	60.3	55.8	50.8	47.8	43.6	42.2	37.1	36.1
16	60.5	61.1	61.0	58.7	55.5	52.3	48.3	46.8	42.5	41.0	35.6	35.4
18	53.2	54.0	54.6	53.4	50.9	47.9	45.6	44.9	40.7	38.8	33.8	34.3
20	47.3	48.0	48.7	48.4	47.0	44.2	42.7	41.8	38.6	36.8	32.0	32.8
22	42.0	42.9	43.7	43.8	43.1	41.1	39.7	38.8	36.7	34.9	30.5	31.3
24	37.4	38.4	39.0	39.2	39.3	38.0	36.9	36.2	34.8	33.3	29.1	29.8
26	30.6	34.4	35.2	35.3	35.5	35.1	34.3	33.6	32.7	31.4	27.9	28.6
28	16.5	31.0	31.8	32.0	32.1	32.0	31.8	31.3	30.5	29.2	26.7	27.3
30		26.7	28.9	29.1	29.2	29.1	29.2	29.0	28.5	27.2	25.6	26.1
32		19.4	26.4	26.5	26.7	26.5	26.7	26.5	26.5	25.4	24.5	24.7
34			23.3	24.3	24.5	24.3	24.4	24.2	24.4	23.6	23.3	23.2
36			18.5	22.3	22.5	22.3	22.4	22.2	22.4	21.7	21.7	21.6
38			10.0	20.0	20.7	20.5	20.6	20.4	20.6	19.9	20.0	20.0
40				16.5	19.0	18.9	19.1	18.8	19.0	18.3	18.5	18.5
42				11.6	17.3	17.4	17.6	17.3	17.5	16.7	17.0	17.0
44					14.6	15.9	16.1	15.9	16.1	15.3	15.6	15.7
46					11.2	14.6	14.9	14.6	14.8	14.0	14.3	14.3
48					5.4	12.4	13.7	13.4	13.6	12.9	13.1	13.2
50						9.8	12.1	12.3	12.5	11.7	12.0	12.0
52						6.3	10.1	10.6	11.5	10.7	10.9	11.0
54							7.6	8.5	10.3	9.8	10.0	10.1
56							3.9	6.0	8.6	8.4	9.2	9.2
58									6.7	6.8	8.2	8.3
60									4.1	4.8	6.8	7.1
62										2.3	5.3	5.7
64											3.4	3.9
66												1.8

60101

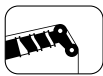

30.1m-70m

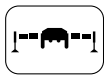

8.9m×8.53m



360°

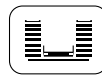

100t



メインブーム 長さ 作業半径(m)	30.1m	35.2m	40.3m	45.3m	50.4m	55.5m	59m	60.5m	64m	65.6m	69.1m	70m
4.5	116.1											
5	118.4											
6	119.0	104.9										
7	116.9	106.9	90.3									
8	108.4	101.6	90.2	75.7								
9	99.6	94.9	88.5	76.1	65.8							
10	91.6	89.2	84.8	76.1	66.0							
11	84.7	83.5	79.6	74.7	66.0	56.5	51.4	48.2				
12	77.6	77.8	74.9	71.0	65.4	56.5	51.4	48.2	44.0	42.8		36.2
13	70.8	71.5	70.7	67.6	63.0	56.4	51.2	48.1	43.9	42.6	37.8	36.4
14	65.0	65.6	66.0	64.3	60.3	55.8	50.8	47.8	43.6	42.2	37.1	36.1
16	55.3	56.2	56.8	57.0	55.5	52.3	48.3	46.8	42.5	41.0	35.6	35.4
18	47.8	48.6	49.4	49.5	49.5	47.7	45.6	44.9	40.7	38.8	33.8	34.3
20	41.8	42.6	43.4	43.5	43.6	42.5	41.8	41.1	38.6	36.8	32.0	32.8
22	36.7	37.6	38.4	38.5	38.7	37.8	37.3	36.7	36.0	34.8	30.5	31.3
24	32.6	33.5	34.2	34.4	34.5	33.9	33.4	32.9	32.5	31.3	29.1	29.7
26	28.7	29.8	30.7	30.8	31.0	30.5	30.1	29.6	29.3	28.2	27.5	27.9
28	16.5	26.5	27.4	27.6	27.8	27.5	27.2	26.7	26.5	25.4	25.2	25.1
30		23.5	24.5	24.8	24.9	24.7	24.6	24.2	24.0	22.9	22.8	22.7
32		19.4	22.0	22.2	22.4	22.2	22.3	21.9	21.7	20.7	20.6	20.6
34			19.7	20.0	20.2	20.0	20.2	19.9	19.8	18.8	18.7	18.7
36			17.7	18.0	18.2	18.0	18.2	17.9	18.0	17.0	17.0	17.0
38			10.0	16.2	16.5	16.3	16.5	16.2	16.4	15.4	15.5	15.5
40				14.6	14.9	14.7	14.9	14.6	14.8	14.0	14.1	14.1
42				11.6	13.5	13.3	13.5	13.2	13.4	12.6	12.8	12.8
44					12.2	12.0	12.2	12.0	12.2	11.4	11.6	11.6
46					10.9	10.8	11.0	10.8	11.0	10.2	10.5	10.5
48					5.4	9.8	10.0	9.7	9.9	9.2	9.4	9.5
50						8.8	9.0	8.7	8.9	8.2	8.5	8.5
52						6.3	8.1	7.8	8.0	7.3	7.5	7.6
54							7.2	6.9	7.2	6.5	6.7	6.7
56							3.9	5.7	6.4	5.7	5.9	6.0
58									5.7	5.0	5.2	5.2
60									4.1	4.3	4.6	4.6
62										2.3	3.9	3.9
64											3.1	3.3
66												1.8

60105

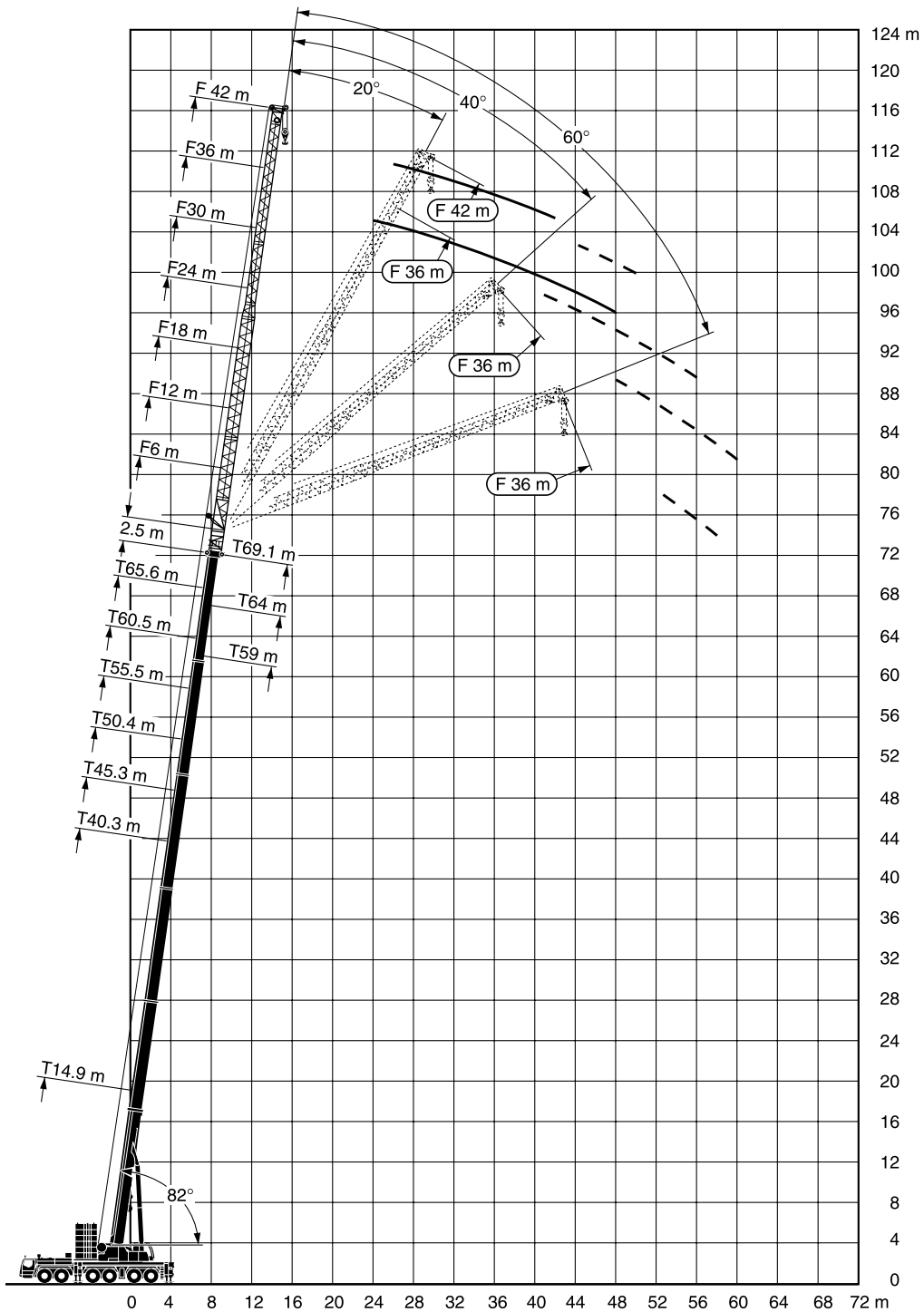

注意

- 1 定格総荷重はフックブロック、玉掛ワイヤー等の自重を含みます。
また、下記の条件が考慮されていませんのでクレーンの操作には充分気をつけてください。
 - ① 地盤の強度、地震による影響
 - ② 作業速度に応じた動荷重および台風または強風による影響等
- 2 本機は水平に設置して、クレーン作業を行ってください。
- 3 作業半径は、クレーンの旋回中心から荷重の重心までの水平距離です。
- 4 メインブームの定格総荷重は補助ジブを取り除いた状態での値です。
- 5 メインブーム70m仕様で200トンを超える定格総荷重の場合は、特殊吊装置が必要です。

固定式ジブ定格総荷重表 TF

LTM 1400NX

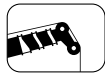

14.9m-65.6m



0°/20°/40°/60°
6m

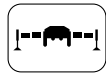

8.9m×8.53m

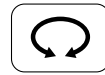

360°

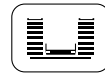

100t

メインブーム長さ ジブ長さ 作業半径(m)	14.9m+2.5m 6m				40.3m+2.5m 6m				45.3m+2.5m 6m				50.4m+2.5m 6m			
	0°	20°	40°	60°	0°	20°	40°	60°	0°	20°	40°	60°	0°	20°	40°	60°
3.5	45.0															
4.0	44.4															
4.5	43.0															
5	41.1															
6	37.4	33.1														
7	34.2	30.6	27.7													
8	31.3	28.4	26.0	24.3	45.0											
9	28.9	26.5	24.5	23.9	44.4											
10	26.8	24.9	23.2	22.8	43.0	34.4			36.2							
11	25.1	23.4	22.1	21.9	41.1	33.1			36.2				29.7			
12	23.4	22.2	21.0	21.1	39.3	31.9	27.2		35.9	31.4			29.4			
13	22.0	21.1	20.1	20.7	37.7	30.7	26.4	24.3	34.8	30.4	26.2		28.8			
14	20.7	20.0	19.3	20.2	36.0	29.6	25.7	24.3	33.3	29.5	25.6	24.1	27.7	27.5		
16	18.6	18.2	18.0	14.6	33.1	27.8	24.4	23.3	30.5	27.7	24.4	23.2	25.5	25.4	24.2	22.9
18	17.0	16.7	16.9	5.5	30.5	26.1	23.2	22.4	28.0	26.2	23.4	22.4	23.5	23.5	23.2	22.1
20	15.7	15.7	9.0		28.4	24.6	22.2		25.7	24.8	22.5	21.7	21.8	21.7	21.8	21.5
22					26.4	23.3	21.3		23.5	23.3	21.5		20.1	20.1	20.2	20.4
24					24.8	22.2	20.5		21.5	21.5	20.7		18.6	18.6	18.7	
26					23.3	21.2	19.7		19.8	19.7	19.6		17.2	17.2	17.2	
28					22.0	20.2	19.1		18.2	18.2	18.3		15.9	15.9	16.0	
30					20.8	19.3	18.5		16.7	16.8	16.8		14.6	14.7	14.8	
32					19.7	18.5	18.0		15.4	15.5	15.6		13.4	13.5	13.7	
34					18.8	17.8			14.2	14.3	14.4		12.4	12.5	12.7	
36					17.7	17.1			13.1	13.2			11.4	11.5	11.7	
38					16.3	16.4			12.2	12.2			10.5	10.6	10.8	
40					14.8	15.1			11.4	11.4			9.7	9.8		
42					13.6				10.7	10.7			9.0	9.0		
44					12.4				10.0	10.0			8.3	8.4		
46					9.0				9.4	9.4			7.7	7.9		
48									8.9				7.2	7.3		
50									8.4				6.8	6.8		
52													6.3			
54													5.9			
56													4.8			

メインブーム長さ ジブ長さ 作業半径(m)	55.5m+2.5m 6m				60.5m+2.5m 6m				65.6m+2.5m 6m			
	0°	20°	40°	60°	0°	20°	40°	60°	0°	20°	40°	60°
12	23.6											
13	23.4											
14	23.1											
16	21.6	21.5			18.7							
18	20.0	20.0	20.3	20.6	17.2	17.1	17.1		14.9			
20	18.6	18.7	18.9	19.3	16.0	16.1	16.2	16.5	14.5	14.2		
22	17.3	17.4	17.6	17.9	15.0	15.1	15.3	15.5	13.8	13.7	13.8	
24	16.0	16.2	16.3	16.6	13.9	14.1	14.4	14.6	13.0	13.0	13.1	13.3
26	14.9	15.0	15.2		13.0	13.2	13.4	13.7	12.3	12.3	12.4	12.7
28	13.8	14.0	14.1		12.1	12.3	12.5		11.5	11.6	11.8	12.0
30	12.8	13.0	13.1		11.3	11.5	11.7		10.8	11.0	11.1	11.3
32	11.9	12.0	12.1		10.5	10.7	10.9		10.1	10.3	10.5	
34	11.0	11.2	11.3		9.8	10.0	10.2		9.4	9.7	9.8	
36	10.2	10.3	10.4		9.1	9.3	9.4		8.8	9.0	9.2	
38	9.4	9.6	9.7		8.4	8.6	8.7		8.2	8.4	8.6	
40	8.6	8.8	8.9		7.8	8.0	8.1		7.6	7.9	8.0	
42	7.9	8.1	8.2		7.2	7.4	7.5		7.1	7.3	7.5	
44	7.3	7.5			6.6	6.8	6.9		6.6	6.8	7.0	
46	6.7	6.9			6.1	6.3			6.1	6.4	6.4	
48	6.2	6.4			5.6	5.8			5.7	5.9	6.0	
50	5.8	5.9			5.2	5.3			5.2	5.4	5.5	
52	5.4	5.5			4.8	4.9			4.8	5.0		
54	5.0	5.1			4.5	4.6			4.4	4.6		
56	4.6				4.1	4.2			4.0	4.2		
58	4.3				3.8	3.9			3.6	3.8		
60	4.0				3.5				3.3	3.4		
62					3.3				3.0	3.1		
64					3.1				2.7	2.8		
66					2.8				2.4			
68									2.1			
70									1.9			
									1.6			

51105/25/45/65

固定式ジブ定格総荷重表 TF

LTM 1400NX



14.9m-65.6m



0°/20°/40°/60°
12m

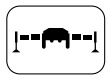

8.9m x 8.53m



360°



100t

メインブーム長さ ジブ長さ 作業半径(m)	14.9m+2.5m 12m				40.3m+2.5m 12m				45.3m+2.5m 12m				50.4m+2.5m 12m			
	0°	20°	40°	60°	0°	20°	40°	60°	0°	20°	40°	60°	0°	20°	40°	60°
4.5	32.4															
5	31.5															
6	29.0															
7	26.9															
8	25.0															
9	23.3	20.3														
10	21.7	19.0			31.2											
11	20.2	17.9			29.8				28.5							
12	18.9	16.9	15.3		28.6				27.5				23.8			
13	17.7	16.0	14.6		27.5				26.5				23.7			
14	16.7	15.2	14.0	12.2	26.4	20.2			25.6				23.5			
16	15.0	13.8	12.9	12.2	24.4	18.9			24.0	18.8			22.2			
18	13.5	12.6	11.9	12.1	22.7	17.8	14.9	12.2	22.5	17.8	14.9		20.7	17.4		
20	12.3	11.7	11.2	11.8	20.9	16.8	14.2	12.2	21.1	16.8	14.3	12.2	19.3	16.6	14.1	
22	11.3	10.9	10.6	11.3	19.5	15.8	13.6	12.2	19.8	16.0	13.7	12.2	18.0	15.8	13.6	12.2
24	10.5	10.3	10.2	4.4	18.2	15.0	13.1	12.2	18.5	15.2	13.2	12.2	16.8	15.1	13.1	12.2
26	9.9	9.8	7.5		17.1	14.3	12.6		17.5	14.5	12.7	12.2	15.6	14.5	12.7	12.2
28					16.1	13.6	12.2		16.4	13.9	12.3		14.6	13.9	12.3	12.0
30					15.1	13.0	11.8		15.4	13.3	12.0		13.6	13.2	12.0	
32					14.3	12.5	11.5		14.4	12.8	11.6		12.6	12.6	11.6	
34					13.6	12.0	11.1		13.4	12.3	11.3		11.7	11.8	11.3	
36					13.0	11.6	10.9		12.4	11.9	11.0		10.8	11.0	10.9	
38					12.3	11.2	10.6		11.5	11.4	10.8		10.1	10.2	10.4	
40					11.8	10.8			10.7	10.9	10.6		9.3	9.5	9.7	
42					11.3	10.5			9.9	10.2			8.6	8.8	9.0	
44					10.9	10.2			9.2	9.5			8.0	8.2	8.4	
46					10.5	10.0			8.5	8.8			7.4	7.6		
48					10.2				8.0	8.2			6.8	7.0		
50					9.9				7.5	7.7			6.3	6.5		
52					6.9				7.1				5.8	6.0		
54									6.7				5.4	5.5		
56									6.3				5.0	5.1		
58													4.7			
60													4.4			
62													3.4			

メインブーム長さ ジブ長さ 作業半径(m)	55.5m+2.5m 12m				60.5m+2.5m 12m				65.6m+2.5m 12m			
	0°	20°	40°	60°	0°	20°	40°	60°	0°	20°	40°	60°
14	18.8											
16	18.4				14.8							
18	17.5				14.5							
20	16.4	15.9			13.9				11.7			
22	15.4	15.2	13.2		13.1	13.1			11.4			
24	14.4	14.5	12.8	12.2	12.4	12.4	11.9		11.0	10.4		
26	13.4	13.7	12.4	12.0	11.6	11.7	11.3		10.5	10.0		
28	12.5	12.8	12.1	11.8	10.9	11.1	10.8	11.4	10.0	9.5	9.2	
30	11.7	12.0	11.8	11.6	10.2	10.5	10.3	10.9	9.5	9.1	8.8	8.8
32	10.9	11.2	11.3		9.5	9.8	9.8	10.4	9.0	8.7	8.5	8.5
34	10.2	10.4	10.7		8.9	9.2	9.3	9.9	8.4	8.3	8.1	8.2
36	9.5	9.7	9.9		8.3	8.6	8.7		7.9	8.0	7.8	7.9
38	8.9	9.0	9.2		7.8	8.1	8.2		7.4	7.6	7.5	
40	8.2	8.4	8.6		7.3	7.5	7.7		6.9	7.1	7.2	
42	7.6	7.8	8.0		6.8	7.0	7.2		6.5	6.7	6.8	
44	7.0	7.2	7.4		6.3	6.5	6.7		6.1	6.3	6.5	
46	6.4	6.7	6.8		5.8	6.0	6.2		5.6	5.9	6.1	
48	5.9	6.2	6.3		5.3	5.5	5.7		5.2	5.5	5.7	
50	5.5	5.7			4.9	5.1	5.3		4.8	5.1	5.3	
52	5.0	5.2			4.5	4.7			4.5	4.8	4.9	
54	4.6	4.7			4.1	4.3			4.1	4.4	4.5	
56	4.3	4.4			3.8	3.9			3.8	4.0	4.1	
58	3.9	4.0			3.5	3.6			3.5	3.7		
60	3.7	3.7			3.2	3.4			3.1	3.4		
62	3.4				3.0	3.1			2.8	3.1		
64	3.2				2.8	2.9			2.5	2.8		
66	3.0				2.6				2.3	2.5		
68					2.4				2.0	2.2		
70					2.2				1.7	2.0		
72					1.7				1.5			

51205/25/45/65

固定式ジブ定格総荷重表 TF

LTM 1400NX



14.9m-65.6m



0°/20°/40°/60°
18m

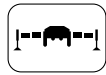

8.9m×8.53m



360°



100t

メインブーム長さ ジブ長さ 作業半径(m)	14.9m+2.5m 18m				40.3m+2.5m 18m				45.3m+2.5m 18m				50.4m+2.5m 18m			
	0°	20°	40°	60°	0°	20°	40°	60°	0°	20°	40°	60°	0°	20°	40°	60°
6	23.5															
7	22.0															
8	20.5															
9	19.3															
10	18.1															
11	17.1				23.3											
12	16.1	13.9			22.3				21.3							
13	15.1	13.2			21.5				20.6							
14	14.3	12.5			20.6				19.9				18.5			
16	12.7	11.3			19.2				18.6				17.6			
18	11.5	10.3	9.8		17.8	13.4			17.5	13.4			16.7			
20	10.4	9.4	9.0	7.1	16.7	12.6			16.5	12.6			15.8	12.2		
22	9.5	8.7	8.4	7.0	15.5	11.9	10.2		15.5	12.0			15.0	12.1		
24	8.7	8.1	7.9	6.9	14.5	11.3	9.8	7.2	14.6	11.4	9.8		14.3	11.5	9.6	
26	8.0	7.5	7.5	6.8	13.5	10.7	9.4	7.1	13.8	10.8	9.4	7.1	13.6	11.0	9.3	
28	7.5	7.1	7.1	6.6	12.7	10.2	9.0	7.0	13.0	10.3	9.1	7.0	12.9	10.5	9.0	7.0
30	7.0	6.7	6.9		12.0	9.7	8.7	7.0	12.2	9.9	8.8	7.0	12.2	10.1	8.7	7.0
32	6.6	6.5			11.3	9.3	8.4		11.6	9.5	8.5	6.9	11.5	9.7	8.4	6.9
34					10.6	8.9	8.1		11.0	9.1	8.2		10.8	9.3	8.2	6.9
36					10.1	8.5	7.9		10.4	8.7	8.0		10.2	9.0	8.0	
38					9.6	8.2	7.7		10.0	8.4	7.8		9.5	8.7	7.8	
40					9.1	7.9	7.5		9.5	8.1	7.6		8.8	8.4	7.6	
42					8.7	7.6	7.3		9.0	7.8	7.4		8.2	8.1	7.4	
44					8.3	7.3	7.1		8.6	7.6	7.2		7.6	7.7	7.3	
46					7.9	7.1			8.2	7.4	7.1		7.0	7.3	7.2	
48					7.6	6.9			7.7	7.2			6.5	6.9	7.0	
50					7.3	6.8			7.2	7.0			6.0	6.4	6.6	
52					7.0	6.6			6.7	6.7			5.6	5.9		
54					6.8				6.2	6.4			5.1	5.5		
56					6.6				5.8	6.0			4.7	5.1		
58					5.3				5.5				4.4	4.7		
60									5.2				4.1	4.3		
62									4.7				3.8	3.9		
64													3.5			
66													3.3			
68													2.4			

メインブーム長さ ジブ長さ 作業半径(m)	55.5m+2.5m 18m				60.5m+2.5m 18m				65.6m+2.5m 18m			
	0°	20°	40°	60°	0°	20°	40°	60°	0°	20°	40°	60°
16	15.4				11.6							
18	15.1				11.6				9.2			
20	14.4				11.3				9.1			
22	13.6	11.5			11.0				8.9			
24	12.8	11.1			10.6	10.3			8.6			
26	12.0	10.6	9.0		10.1	9.9			8.3	7.9		
28	11.3	10.2	8.8	7.0	9.6	9.5			8.0	7.6		
30	10.6	9.8	8.5	6.9	9.1	9.0	8.2	6.9	7.7	7.2	6.8	
32	9.9	9.5	8.3	6.9	8.6	8.6	8.0	6.9	7.3	6.9	6.6	
34	9.3	9.1	8.1	6.9	8.1	8.2	7.8	6.9	7.0	6.6	6.4	6.3
36	8.7	8.8	7.9	6.9	7.6	7.8	7.6	6.9	6.6	6.4	6.1	6.2
38	8.1	8.4	7.7		7.1	7.4	7.3	6.9	6.3	6.1	5.9	5.9
40	7.6	7.9	7.5		6.7	7.0	7.0		5.9	5.9	5.7	5.7
42	7.1	7.4	7.4		6.2	6.6	6.7		5.5	5.6	5.5	
44	6.6	6.9	7.1		5.8	6.2	6.3		5.2	5.3	5.3	
46	6.1	6.4	6.7		5.4	5.8	6.0		4.8	5.1	5.1	
48	5.7	6.0	6.2		5.0	5.3	5.6		4.5	4.8	4.8	
50	5.2	5.6	5.8		4.7	5.0	5.2		4.2	4.5	4.6	
52	4.8	5.2	5.3		4.3	4.6	4.8		3.9	4.2	4.4	
54	4.4	4.8	4.9		4.0	4.2	4.4		3.6	3.9	4.0	
56	4.0	4.4			3.7	3.9	4.1		3.3	3.6	3.7	
58	3.7	4.0			3.3	3.6			3.0	3.3	3.4	
60	3.4	3.6			3.0	3.3			2.7	3.0	3.2	
62	3.2	3.3			2.8	3.0			2.5	2.7		
64	3.0	3.1			2.6	2.7			2.2	2.4		
66	2.7	2.8			2.4	2.5			1.9	2.2		
68	2.6				2.2	2.3			1.7	1.9		
70	2.4				2.0	2.1			1.5	1.7		
72	2.2				1.8				1.2	1.4		
74					1.7					1.2		
76					1.5							

51305/25/45/65

固定式ジブ定格総荷重表 TF

LTM 1400NX



14.9m-65.6m



0°/20°/40°/60°
24m

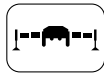

8.9m×8.53m

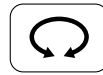

360°



100t

メインブーム長さ ジブ長さ 作業半径(m)	14.9m+2.5m 24m				40.3m+2.5m 24m				45.3m+2.5m 24m				50.4m+2.5m 24m			
	0°	20°	40°	60°	0°	20°	40°	60°	0°	20°	40°	60°	0°	20°	40°	60°
7	17.9															
8	17.0															
9	16.0															
10	15.1															
11	14.3															
12	13.5				17.7											
13	12.8				17.1				16.3							
14	12.2				16.5				15.8							
16	11.0	10.0			15.3				14.8				13.9			
18	9.8	9.0			14.3				13.9				13.2			
20	8.9	8.2			13.4	10.4			13.1				12.5			
22	8.1	7.5	6.8		12.6	9.8			12.4	9.7			11.9			
24	7.4	6.9	6.4		11.8	9.2			11.7	9.2			11.3	9.0		
26	6.8	6.4	6.0	4.3	11.0	8.7	7.0		11.1	8.7			10.7	8.6		
28	6.2	6.0	5.6	4.2	10.3	8.3	6.7		10.4	8.3	6.7		10.2	8.2		
30	5.8	5.6	5.3	4.1	9.7	7.8	6.5	4.3	9.9	7.9	6.5		9.7	7.8	6.5	
32	5.3	5.2	5.0	4.1	9.1	7.5	6.3	4.2	9.3	7.5	6.3	4.3	9.3	7.5	6.3	4.2
34	5.0	4.9	4.8	4.0	8.6	7.1	6.1	4.2	8.8	7.2	6.1	4.2	8.8	7.2	6.1	4.2
36	4.7	4.7	4.6		8.1	6.8	5.9	4.2	8.3	6.9	5.9	4.2	8.4	6.9	5.9	4.2
38	4.5	4.5			7.6	6.5	5.7		7.9	6.6	5.7	4.1	8.0	6.6	5.7	4.1
40					7.2	6.2	5.5		7.5	6.3	5.5		7.6	6.4	5.5	4.1
42					6.8	5.9	5.3		7.1	6.1	5.4		7.3	6.1	5.4	
44					6.5	5.7	5.2		6.8	5.9	5.2		6.9	5.9	5.3	
46					6.2	5.5	5.0		6.5	5.7	5.1		6.5	5.7	5.1	
48					5.9	5.3	4.9		6.2	5.5	5.0		6.1	5.5	5.0	
50					5.6	5.1	4.8		5.9	5.3	4.9		5.6	5.4	4.9	
52					5.4	4.9			5.7	5.1	4.8		5.3	5.2	4.8	
54					5.2	4.8			5.4	5.0			4.8	5.0	4.8	
56					4.9	4.7			5.2	4.8			4.5	4.8	4.7	
58					4.8	4.6			5.0	4.7			4.1	4.5		
60					4.6				4.7	4.6			3.8	4.2		
62					4.5				4.3	4.5			3.4	3.8		
64					3.8				4.1				3.2	3.5		
66									3.8				3.0	3.2		
68									3.4				2.8	2.9		
70													2.6			
72													2.4			
74													1.6			

メインブーム長さ ジブ長さ 作業半径(m)	55.5m+2.5m 24m				60.5m+2.5m 24m				65.6m+2.5m 24m			
	0°	20°	40°	60°	0°	20°	40°	60°	0°	20°	40°	60°
18	11.9				9.6							
20	11.6				9.5				7.5			
22	11.2				9.3				7.4			
24	10.8				9.0				7.2			
26	10.3	8.3			8.7				6.9			
28	9.9	7.9			8.3	7.4			6.7			
30	9.4	7.6			7.9	7.2			6.4	5.8		
32	8.9	7.3	6.2		7.5	6.9			6.2	5.6		
34	8.4	7.0	6.0	4.2	7.1	6.7	5.8		5.9	5.4		
36	7.9	6.8	5.8	4.1	6.7	6.5	5.6	4.1	5.6	5.2	4.6	
38	7.4	6.5	5.6	4.1	6.3	6.2	5.5	4.1	5.4	5.0	4.5	
40	6.9	6.3	5.5	4.1	6.0	6.0	5.3	4.1	5.1	4.8	4.4	4.1
42	6.5	6.1	5.3	4.1	5.6	5.8	5.2	4.1	4.8	4.6	4.2	4.1
44	6.1	5.9	5.2		5.2	5.5	5.1	4.1	4.5	4.4	4.1	4.1
46	5.7	5.7	5.1		4.9	5.2	5.0		4.2	4.2	4.0	4.0
48	5.3	5.4	5.0		4.5	4.9	4.9		4.0	4.0	3.9	
50	4.9	5.2	4.9		4.2	4.6	4.7		3.7	3.8	3.7	
52	4.5	4.9	4.8		3.9	4.3	4.5		3.4	3.7	3.6	
54	4.2	4.5	4.6		3.6	4.0	4.2		3.1	3.5	3.5	
56	3.9	4.2	4.4		3.3	3.7	3.9		2.9	3.2	3.3	
58	3.5	3.8	4.0		3.0	3.4	3.6		2.6	3.0	3.2	
60	3.2	3.5			2.7	3.1	3.3		2.4	2.7	3.0	
62	2.9	3.2			2.5	2.8	3.0		2.1	2.5	2.8	
64	2.7	2.9			2.3	2.5			1.9	2.2	2.5	
66	2.5	2.7			2.0	2.3			1.7	2.0	2.2	
68	2.3	2.4			1.8	2.1			1.4	1.8		
70	2.1	2.2			1.7	1.8			1.2	1.5		
72	1.9	2.0			1.5	1.6				1.2		
74	1.7				1.3	1.4						
76	1.5					1.3						

51405/25/45/65

固定式ジブ定格総荷重表 TF

LTM 1400NX



14.9m-65.6m



0°/20°/40°/60°
30m



8.9m×8.53m



360°



100t

メインブーム長さ ジブ長さ 作業半径(m)	14.9m+2.5m 30m				40.3m+2.5m 30m				45.3m+2.5m 30m				50.4m+2.5m 30m			
	0°	20°	40°	60°	0°	20°	40°	60°	0°	20°	40°	60°	0°	20°	40°	60°
8	12.2															
9	12.2															
10	12.2															
11	12.2															
12	11.8															
13	11.2				12.2											
14	10.7				12.2				12.2							
16	9.7				12.2				12.2				11.3			
18	8.9	7.6			12.0				11.6				10.9			
20	8.0	7.1			11.3				11.0				10.3			
22	7.3	6.5			10.6				10.4				9.8			
24	6.6	6.0			10.0	7.4			9.8				9.4			
26	6.0	5.5	4.6		9.4	7.1			9.3	7.0			8.9			
28	5.5	5.1	4.4		8.9	6.7			8.8	6.7			8.5	6.6		
30	5.1	4.7	4.1		8.3	6.4			8.3	6.4			8.1	6.3		
32	4.7	4.3	3.9	2.7	7.8	6.0	4.5		7.9	6.1			7.8	6.0		
34	4.3	4.0	3.7	2.7	7.3	5.7	4.4		7.5	5.8	4.4		7.4	5.7	4.4	
36	4.0	3.8	3.6	2.7	6.9	5.4	4.2	2.8	7.0	5.5	4.2		7.0	5.5	4.2	
38	3.7	3.5	3.4	2.6	6.5	5.2	4.1	2.7	6.7	5.2	4.1	2.7	6.7	5.2	4.1	2.7
40	3.5	3.4	3.3	2.6	6.1	4.9	4.0	2.7	6.3	5.0	4.0	2.7	6.3	5.0	4.0	2.7
42	3.3	3.2	3.2		5.8	4.7	3.9		6.0	4.8	3.9	2.7	6.0	4.8	3.9	2.7
44	3.2	3.1			5.4	4.5	3.8		5.7	4.6	3.8	2.7	5.7	4.6	3.8	2.7
46					5.1	4.3	3.7		5.4	4.4	3.7		5.5	4.4	3.7	2.6
48					4.9	4.1	3.6		5.1	4.2	3.6		5.2	4.3	3.7	
50					4.6	3.9	3.5		4.9	4.1	3.6		5.0	4.1	3.6	
52					4.4	3.8	3.5		4.6	3.9	3.5		4.8	3.9	3.5	
54					4.2	3.6	3.4		4.4	3.8	3.4		4.5	3.8	3.5	
56					4.0	3.5	3.3		4.2	3.6	3.4		4.3	3.7	3.4	
58					3.8	3.4			4.0	3.5	3.3		3.9	3.6	3.3	
60					3.6	3.3			3.9	3.4			3.7	3.5	3.3	
62					3.5	3.2			3.7	3.3			3.4	3.4	3.3	
64					3.4	3.2			3.6	3.3			3.1	3.3		
66					3.3				3.4	3.2			2.9	3.1		
68					3.2				3.3	3.1			2.6	2.9		
70									3.1				2.4	2.6		
72									3.0				2.2	2.4		
74									2.6				2.0	2.2		
76													1.9			
78													1.7			

メインブーム長さ ジブ長さ 作業半径(m)	55.5m+2.5m 30m				60.5m+2.5m 30m				65.6m+2.5m 30m			
	0°	20°	40°	60°	0°	20°	40°	60°	0°	20°	40°	60°
18	9.6											
20	9.4				7.8							
22	9.0				7.7				5.9			
24	8.7				7.5				5.8			
26	8.3				7.4				5.7			
28	8.0				7.1				5.5			
30	7.7	6.0			6.8				5.3			
32	7.4	5.8			6.5	5.4			5.1			
34	7.0	5.5			6.2	5.2			4.9	4.2		
36	6.7	5.3	4.2		5.9	5.0			4.6	4.1		
38	6.4	5.1	4.1		5.6	4.9			4.5	3.9		
40	6.1	4.9	4.0	2.7	5.3	4.7	3.9		4.3	3.7		
42	5.8	4.7	3.9	2.7	5.0	4.5	3.8	2.6	4.1	3.6	3.2	
44	5.5	4.5	3.8	2.6	4.7	4.4	3.7	2.6	3.9	3.5	3.1	
46	5.2	4.4	3.7	2.6	4.4	4.2	3.6	2.6	3.7	3.4	3.1	2.6
48	4.9	4.2	3.6	2.6	4.1	4.1	3.6	2.6	3.4	3.3	3.0	2.6
50	4.5	4.1	3.6		3.8	3.9	3.5	2.6	3.2	3.2	2.9	2.6
52	4.2	3.9	3.5		3.5	3.8	3.4		3.0	3.0	2.8	2.6
54	3.9	3.8	3.4		3.2	3.6	3.4		2.7	2.9	2.8	
56	3.6	3.7	3.4		3.0	3.4	3.3		2.5	2.8	2.7	
58	3.3	3.5	3.3		2.7	3.2	3.3		2.3	2.7	2.6	
60	3.0	3.3	3.3		2.4	2.9	3.2		2.0	2.5	2.6	
62	2.7	3.1	3.2		2.2	2.7	3.0		1.8	2.3	2.5	
64	2.5	2.9	3.1		2.0	2.4	2.7		1.6	2.1	2.3	
66	2.2	2.6			1.7	2.2	2.5		1.4	1.8	2.1	
68	2.0	2.3			1.5	1.9	2.2			1.6	1.9	
70	1.8	2.1			1.3	1.7				1.4	1.7	
72	1.6	1.8				1.4					1.4	
74	1.4	1.6				1.2						
76	1.2	1.4										
78		1.2										

51505/25/45/65

固定式ジブ定格総荷重表 TF

LTM 1400NX



14.9m-70m



0°/20°/40°/60°
36m

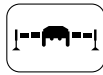

8.9m×8.53m

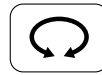

360°

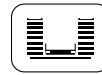

100t

メイン長さ ジブ長さ (m)	14.9m+2.5m 36m				40.3m+2.5m 36m				45.3m+2.5m 36m				50.4m+2.5m 36m				55.5m+2.5m 36m			
	角度				角度				角度				角度				角度			
	0°	20°	40°	60°	0°	20°	40°	60°	0°	20°	40°	60°	0°	20°	40°	60°	0°	20°	40°	60°
9	10.9																			
10	10.6																			
11	10.2																			
12	9.7																			
13	9.3																			
14	9.0				10.9															
16	8.3				10.3				9.8											
18	7.6				9.7				9.3				8.7							
20	7.0				9.2				8.8				8.3							
22	6.4	5.4			8.7				8.4				7.9						7.5	
24	5.8	5.0			8.2				8.0				7.6						7.3	
26	5.3	4.6			7.8				7.6				7.3						7.0	
28	4.8	4.2			7.4	5.3			7.3				6.9						6.7	
30	4.4	3.9			7.0	5.0			6.9	5.0			6.6						6.5	
32	4.0	3.7	3.0		6.5	4.8			6.5	4.8			6.3	4.7					6.2	
34	3.7	3.4	2.9		6.1	4.5			6.2	4.5			6.0	4.4					6.0	
36	3.4	3.2	2.7		5.7	4.3	3.1		5.8	4.3			5.8	4.2					5.7	4.3
38	3.2	3.0	2.6	1.5	5.4	4.1	3.0		5.5	4.1	3.0		5.5	4.0					5.5	4.1
40	3.0	2.8	2.5	1.5	5.1	3.9	2.9		5.2	3.9	2.9		5.2	3.9	2.9				5.3	3.9
42	2.8	2.6	2.4	1.4	4.8	3.7	2.8	1.7	4.9	3.7	2.8		4.9	3.7	2.8				5.0	3.7
44	2.6	2.5	2.4	1.4	4.5	3.5	2.8	1.6	4.7	3.6	2.8	1.6	4.7	3.6	2.8	1.6			4.8	3.6
46	2.5	2.4	2.3	1.4	4.2	3.4	2.7	1.6	4.4	3.4	2.7	1.6	4.4	3.4	2.7	1.6			4.6	3.5
48	2.3	2.3	2.3		4.0	3.3	2.6		4.1	3.3	2.6	1.6	4.2	3.3	2.6	1.6			4.3	3.4
50	2.2	2.2			3.8	3.1	2.5		3.9	3.2	2.6	1.6	4.0	3.2	2.6	1.6			4.4	3.4
52					3.6	3.0	2.5		3.7	3.1	2.5		3.8	3.1	2.5	1.6			4.6	3.5
54					3.4	2.9	2.4		3.5	3.0	2.5		3.6	3.0	2.5				4.8	3.6
56					3.2	2.8	2.4		3.4	2.9	2.4		3.5	2.9	2.4				5.0	3.7
58					3.1	2.7	2.4		3.2	2.8	2.4		3.3	2.8	2.4				5.3	3.9
60					2.9	2.6	2.3		3.1	2.7	2.4		3.2	2.7	2.4				5.5	4.1
62					2.8	2.5	2.3		3.0	2.6	2.3		3.0	2.6	2.3				5.7	4.3
64					2.7	2.4			2.8	2.5	2.3		2.8	2.6	2.3				6.0	4.4
66					2.6	2.3			2.7	2.4			2.7	2.5	2.3				6.2	4.6
68					2.5	2.3			2.6	2.4			2.5	2.4	2.3				6.3	4.7
70					2.4	2.2			2.5	2.3			2.2	2.3					6.6	5.0
72					2.3				2.4	2.3			2.0	2.3					6.9	5.3
74					2.2				2.4	2.2			1.8	2.1					7.0	3.7
76									2.3				1.6	1.9					7.3	4.1
78									2.2				1.4	1.6					7.6	4.8
80									1.9				1.3	1.4					8.0	5.0

メイン長さ ジブ長さ (m)	59.0m+2.5m 36m				60.5m+2.5m 36m				64.0m+2.5m 36m				65.6m+2.5m 36m				69.1m+2.5m 36m				70.0m+2.5m 36m
	角度				角度				角度				角度				角度				角度
	0°	20°	40°	60°	0°	20°	40°	60°	0°	20°	40°	60°	0°	20°	40°	60°	0°	20°	40°	60°	0°
22	5.1				6.2																
24	4.9				6.1				4.4				4.3				2.9				2.5
26	4.7				5.9				4.4				4.3				2.9				2.5
28	4.5				5.8				4.2				4.2				2.9				2.5
30	4.3				5.6				4.1				4.1				2.9				2.5
32	4.0				5.4				3.8				4.0				2.8				2.5
34	3.8				5.2				3.6				3.9				2.8				2.5
36	3.5	3.1			5.0	3.8			3.3				3.8				2.7				2.4
38	3.3	3.0			4.8	3.7			3.1	2.9			3.6	3.1			2.6				2.4
40	3.0	2.8			4.6	3.5			2.9	2.8			3.5	3.0			2.5				2.3
42	2.7	2.7			4.3	3.4			2.6	2.7			3.3	2.9			2.4	2.7			2.2
44	2.5	2.6			4.1	3.3	2.7		2.4	2.6			3.2	2.8			2.2	2.5			2.1
46	2.2	2.5	2.2		3.9	3.2	2.6		2.2	2.5			3.0	2.7			2.0	2.4			1.9
48	1.9	2.4	2.1		3.6	3.1	2.6	1.6	2.0	2.4	2.1		2.9	2.6			1.7	2.3			1.7
50	1.6	2.3	2.0	1.6	3.3	3.0	2.5	1.6	1.7	2.2	2.0		2.7	2.5	2.2		1.5	2.1			1.4
52	1.3	2.1	2.0	1.6	3.1	3.0	2.5	1.6	1.4	2.1	2.0	1.6	2.5	2.4	2.1	1.6	1.3	1.9	2.0		1.2
54		1.9	1.9	1.6	2.9	2.9	2.4	1.6	1.2	1.9	1.9	1.6	2.3	2.3	2.1	1.6		1.7	1.9	1.6	
56		1.6	1.9		2.6	2.8	2.4	1.6		1.7	1.9	1.6	2.1	2.2	2.0	1.6		1.5	1.8	1.6	
58		1.3	1.8		2.4	2.7	2.4			1.4	1.8		2.0	2.2	2.0	1.6		1.3	1.7	1.6	
60			1.6		2.1	2.6	2.3				1.7		1.8	2.0	1.9				1.6		
62			1.4		1.9	2.5	2.3				1.5		1.5	1.9	1.9				1.4		
64					1.7	2.2	2.3				1.2		1.3	1.8	1.8						
66					1.5	2.0	2.2						1.7	1.8							
68					1.2	1.8	2.1						1.5	1.7							
70						1.6	1.9							1.6							
72						1.3	1.7							1.2							
74							1.4														
76																					
78																					
80																					

51605/25/45/65

固定式ジブ定格総荷重表 TF

LTM 1400NX

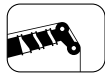

14.9m-69.1m



0°/20°/40°
42m

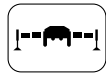

8.9m×8.53m



360°

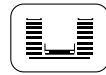

100t

メインブーム長さ ジブ長さ 作業半径(m)	14.9m+2.5m 42m			40.3m+2.5m 42m			45.3m+2.5m 42m			50.4m+2.5m 42m			55.5m+2.5m 42m		
	0°	20°	40°	0°	20°	40°	0°	20°	40°	0°	20°	40°	0°	20°	40°
10	8.5														
11	8.3														
12	8.0														
13	7.7														
14	7.4														
16	6.8				8.3										
18	6.3				7.8			7.5							
20	5.9				7.4			7.1			6.6				
22	5.4				7.0			6.7			6.3			5.8	
24	5.0				6.7			6.4			6.0			5.5	
26	4.6	3.8			6.3			6.1			5.8			5.3	
28	4.2	3.5			6.0			5.8			5.5			5.1	
30	3.8	3.3			5.7			5.5			5.3			4.9	
32	3.5	3.0			5.4	3.8		5.3	3.7		5.1			4.7	
34	3.2	2.8			5.0	3.6		5.0	3.5		4.8	3.4		4.5	
36	3.0	2.6	2.1		4.8	3.4		4.7	3.4		4.6	3.3		4.4	3.1
38	2.8	2.5	1.9		4.5	3.2		4.5	3.2		4.4	3.1		4.2	3.0
40	2.6	2.3	1.8		4.2	3.1		4.3	3.1		4.2	3.0		4.0	2.9
42	2.4	2.2	1.7		4.0	2.9	2.1	4.0	2.9		4.0	2.9		3.8	2.8
44	2.2	2.0	1.6		3.7	2.8	2.1	3.8	2.8	2.1	3.8	2.8	2.0	3.6	2.7
46	2.1	1.9	1.5		3.5	2.7	2.0	3.6	2.7	2.0	3.6	2.7	2.0	3.5	2.6
48	1.9	1.8	1.4		3.3	2.6	1.9	3.4	2.6	1.9	3.4	2.6	1.9	3.3	2.5
50	1.8	1.7	1.4		3.1	2.4	1.8	3.2	2.5	1.9	3.3	2.5	1.9	3.2	2.4
52	1.7	1.6	1.4		3.0	2.3	1.8	3.1	2.4	1.8	3.1	2.4	1.8	3.0	2.3
54	1.6	1.5	1.4		2.8	2.3	1.7	2.9	2.3	1.7	3.0	2.3	1.8	2.9	2.2
56	1.5	1.5			2.7	2.2	1.7	2.8	2.2	1.7	2.8	2.2	1.7	2.7	2.2
58					2.6	2.1	1.6	2.7	2.1	1.7	2.7	2.1	1.7	2.6	2.1
60					2.4	2.0	1.6	2.5	2.0	1.6	2.6	2.1	1.6	2.4	2.0
62					2.3	1.9	1.6	2.4	2.0	1.6	2.5	2.0	1.6	2.2	2.0
64					2.2	1.9	1.6	2.3	1.9	1.6	2.4	1.9	1.6	2.0	1.9
66					2.1	1.8	1.5	2.2	1.8	1.5	2.2	1.9	1.5	1.8	1.8
68					2.0	1.7		2.1	1.8	1.5	2.1	1.8	1.5	1.6	1.8
70					1.9	1.7		2.0	1.7	1.5	2.0	1.8	1.5	1.4	1.7
72					1.8	1.6		1.9	1.7		1.8	1.7	1.5		1.6
74					1.7	1.6		1.8	1.6		1.6	1.7	1.5		1.5
76					1.6	1.5		1.8	1.6		1.4	1.6			1.5
78					1.6			1.7	1.5		1.2	1.5			1.3
80					1.5			1.6	1.5			1.4			
82								1.6				1.2			
84								1.5							

メインブーム長さ ジブ長さ 作業半径(m)	59.0m+2.5m 42m		60.5m+2.5m 42m			64.0m+2.5m 42m		65.6m+2.5m 42m		69.1m+2.5m 42m	
	0°	20°	0°	20°	40°	0°	20°	0°	20°	0°	20°
24	3.9		4.9								
26	3.7		4.7			3.3		3.2		1.6	
28	3.5		4.6			3.3		3.2		1.6	
30	3.4		4.4			3.2		3.1		1.6	
32	3.2		4.2			3.0		3.0		1.6	
34	3.1		4.1			2.9		3.0		1.6	
36	2.9		3.9			2.8		2.9		1.6	
38	2.7		3.8			2.6		2.8		1.6	
40	2.5		3.6	2.7		2.4		2.7		1.5	
42	2.3	2.1	3.5	2.6		2.2	2.0	2.6		1.5	
44	2.1	2.0	3.4	2.6		2.0	1.9	2.5	2.1	1.4	
46	1.8	1.9	3.2	2.5		1.7	1.8	2.4	2.0	1.3	1.7
48	1.5	1.8	3.1	2.4		1.4	1.7	2.2	1.9		1.6
50	1.2	1.7	2.9	2.3		1.2	1.6	2.1	1.9		1.5
52		1.6	2.7	2.2	1.7		1.5	2.0	1.8		1.4
54		1.5	2.5	2.2	1.7		1.4	1.9	1.7		1.4
56		1.3	2.3	2.1	1.7		1.3	1.7	1.6		
58			2.1	2.0	1.6			1.6	1.6		
60			1.9	2.0	1.6			1.4	1.5		
62			1.7	1.9	1.6			1.2	1.4		
64			1.5	1.9	1.5				1.3		
66			1.2	1.8	1.5				1.2		
68				1.6	1.5						
70				1.4	1.5						
72				1.2	1.5						
74					1.4						
76					1.2						

51705/25/45

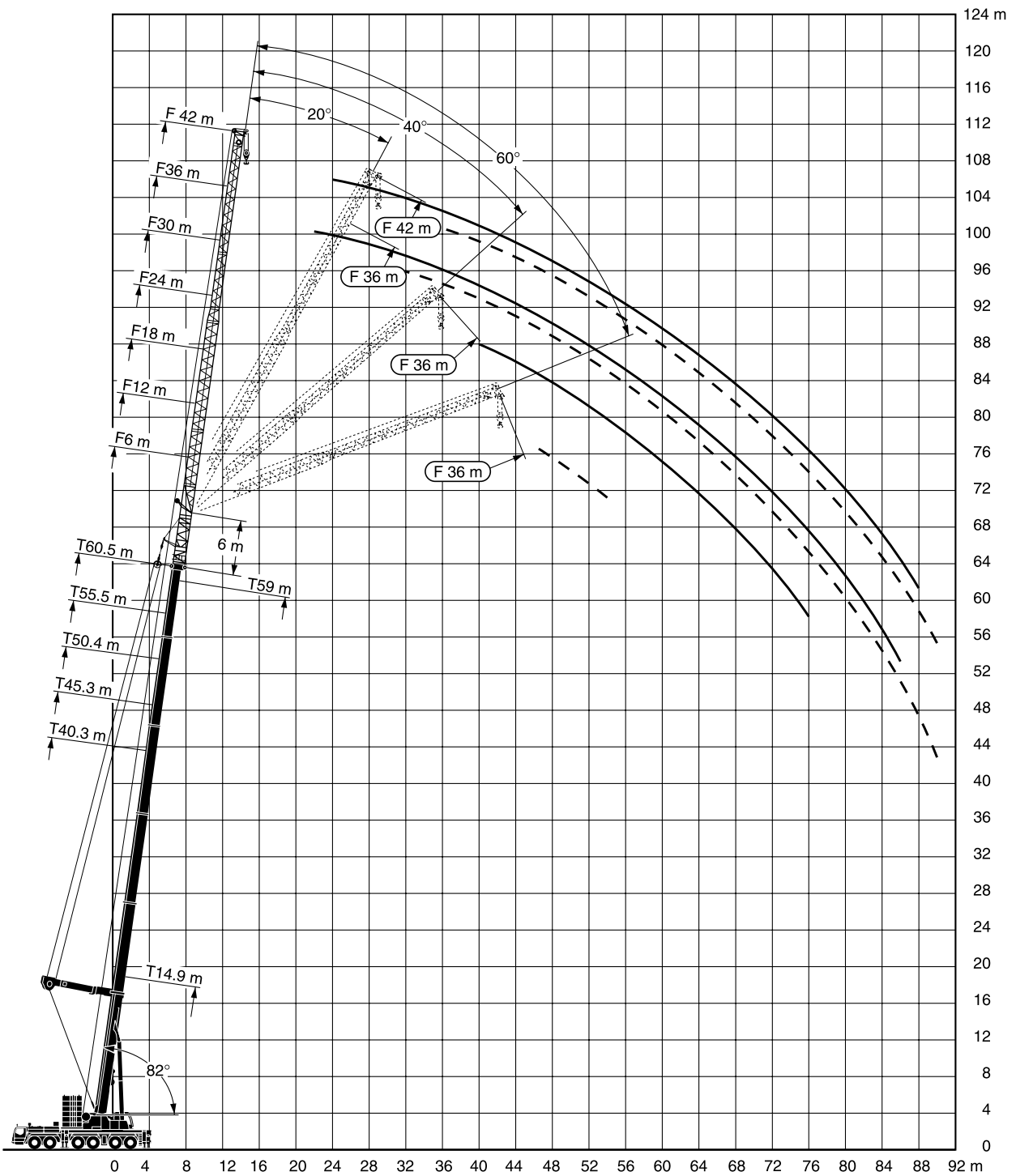

注意

- 1 定格総荷重はフックブロック、玉掛ワイヤー等の自重を含みます。
また、下記の条件が考慮されていませんのでクレーンの操作には充分気をつけてください。
 - ① 地盤の強度、地震による影響
 - ② 作業速度に応じた動荷重および台風または強風による影響等
- 2 本機は水平に設置して、クレーン作業を行ってください。
- 3 作業半径は、クレーンの旋回中心から荷重の重心までの水平距離です。
- 4 メインブームの定格総荷重は補助ジブを取り除いた状態での値です。
- 5 メインブーム70m仕様で200トンを超える定格総荷重の場合は、特殊吊装置が必要です。

固定式ジブ (ガイ、エクセンダー仕様) 定格総荷重表 TYVEF

LTM 1400NX

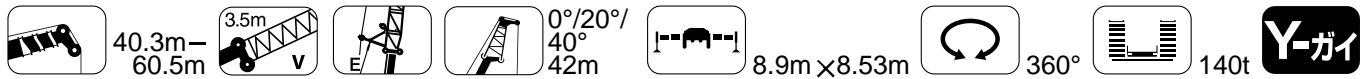

メインブーム長さ ジブ長さ 作業半径(m)	40.3m+6m 42m			45.3m+6m 42m			50.4m+6m 42m			55.5m+6m 42m			60.5m+6m 42m	
	0°	20°	40°	0°	20°	40°	0°	20°	40°	0°	20°	40°	0°	20°
16	9.9													
18	9.3			9.3			9.2			9.1				
20	8.7			8.7			8.7			8.7				
22	8.2			8.2			8.3			8.3			8.0	
24	7.7			7.8			7.8			7.8			7.7	
26	7.3			7.4			7.4			7.4			7.3	
28	6.9			7.0			7.1			7.1			7.0	
30	6.5	4.4		6.6			6.7			6.8			6.7	
32	6.2	4.2		6.3	4.2		6.4	4.3		6.4			6.4	
34	5.9	4.0		6.0	4.0		6.1	4.1		6.2	4.1		6.1	
36	5.6	3.8		5.7	3.8		5.8	3.9		5.9	3.9		5.8	3.9
38	5.3	3.6		5.4	3.6		5.6	3.7		5.6	3.8		5.6	3.8
40	5.0	3.4	2.4	5.2	3.5		5.3	3.5		5.4	3.6		5.4	3.6
42	4.7	3.2	2.3	4.9	3.3	2.3	5.1	3.4	2.3	5.2	3.4		5.2	3.4
44	4.4	3.1	2.2	4.7	3.2	2.2	4.8	3.2	2.2	4.9	3.3	2.3	4.9	3.3
46	4.2	2.9	2.1	4.4	3.0	2.1	4.6	3.1	2.2	4.7	3.2	2.2	4.8	3.2
48	3.9	2.8	2.0	4.2	2.9	2.1	4.4	3.0	2.1	4.5	3.1	2.1	4.6	3.1
50	3.7	2.7	2.0	4.0	2.8	2.0	4.2	2.9	2.0	4.3	2.9	2.1	4.4	3.0
52	3.5	2.6	1.9	3.8	2.7	1.9	4.0	2.8	2.0	4.2	2.8	2.0	4.2	2.9
54	3.3	2.5	1.8	3.6	2.6	1.9	3.8	2.7	1.9	4.0	2.7	1.9	4.0	2.8
56	3.2	2.4	1.8	3.4	2.5	1.8	3.6	2.6	1.9	3.8	2.6	1.9	3.9	2.7
58	3.0	2.3	1.7	3.2	2.4	1.8	3.4	2.5	1.8	3.6	2.5	1.8	3.7	2.6
60	2.8	2.2	1.7	3.1	2.3	1.7	3.3	2.4	1.8	3.5	2.4	1.8	3.5	2.5
62	2.7	2.1	1.7	2.9	2.2	1.7	3.1	2.3	1.7	3.3	2.4	1.8	3.4	2.4
64	2.5	2.0	1.6	2.8	2.1	1.6	3.0	2.2	1.7	3.1	2.3	1.7	3.3	2.3
66	2.4	2.0	1.6	2.6	2.1	1.6	2.9	2.1	1.6	3.0	2.2	1.7	3.1	2.3
68	2.3	1.9	1.6	2.5	2.0	1.6	2.7	2.1	1.6	2.9	2.1	1.6	3.0	2.2
70	2.2	1.8		2.4	1.9	1.6	2.6	2.0	1.6	2.8	2.1	1.6	2.9	2.1
72	2.1	1.8		2.3	1.9		2.5	1.9	1.6	2.7	2.0	1.6	2.8	2.0
74	2.0	1.7		2.2	1.8		2.4	1.9	1.5	2.5	1.9	1.6	2.7	2.0
76	1.9	1.7		2.1	1.8		2.3	1.8		2.4	1.9	1.5	2.6	1.9
78	1.8			2.0	1.7		2.2	1.8		2.3	1.8	1.5	2.4	1.9
80	1.7			1.9	1.7		2.1	1.7		2.2	1.8		2.3	1.8
82	1.3			1.8	1.6		2.0	1.7		2.1	1.7		2.2	1.8
84				1.6			1.9	1.6		2.0	1.7		2.1	1.7
86							1.8	1.6		2.0	1.7		2.0	1.7
88							1.6			1.7	1.6		1.7	1.7
90										1.3	1.6			1.5
92											1.5			

61701/61721/61741

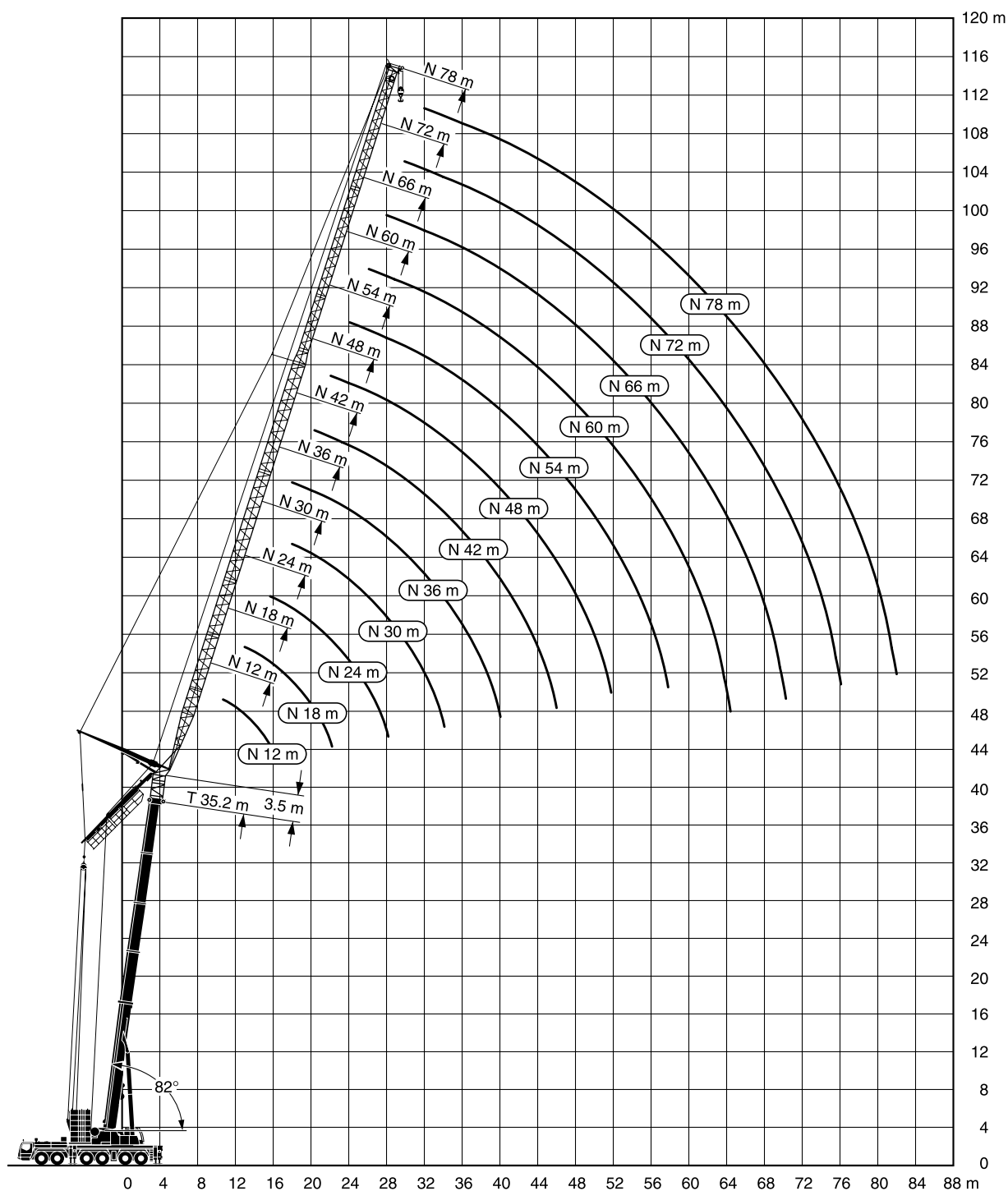

注意

- 1 定格総荷重はフックブロック、玉掛ワイヤー等の自重を含みます。
また、下記の条件が考慮されていないのでクレーンの操作には充分気をつけてください。
① 地盤の強度、地震による影響
② 作業速度に応じた動荷重および台風または強風による影響等
- 2 本機は水平に設置して、クレーン作業を行ってください。
- 3 作業半径は、クレーンの旋回中心から荷重の重心までの水平距離です。
- 4 メインブームの定格総荷重は補助ジブを取り除いた状態での値です。
- 5 メインブーム70m仕様で200トンを超える定格総荷重の場合は、特殊吊装置が必要です。

起伏式ジブ定格総荷重表 TN

LTM 1400NX



14.9m-45.3m

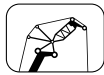

82°/75°/68°
12m

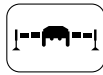

8.9m x 8.53m

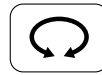

360°

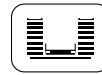

100t

メイン長さ ジブ長さ (m)	14.9m+3.5m			20.0m+3.5m			25.0m+3.5m			30.1m+3.5m			35.2m+3.5m			40.3m+3.5m			45.3m+3.5m	
	12m			12m			12m			12m			12m			12m			12m	
角度	82°	75°	68°	82°	75°	68°	82°	75°	68°	82°	75°	68°	82°	75°	68°	82°	75°	68°	82°	75°
7	70.8																			
8	70.8			70.8																
9	70.8			70.8			64.4													
10	69.3			69.9			65.1			53.2										
11	66.0	67.0		68.4			64.9			53.5			44.7							
12	61.5	62.6		65.7	67.8		63.7			53.6			44.7			34.0				
13	55.0	59.4		60.3	65.1		62.9			53.9			44.8			34.0				26.3
14	49.1	56.9	58.1	53.9	62.0		59.4	61.7		54.4			45.0			34.0				26.2
16		50.5	51.8		57.0	56.4		57.3		53.9	51.8		45.8			33.6				26.2
18			49.5			50.2		50.9			49.2			42.6						26.2
20						45.0				43.2			44.1						28.0	
22										39.2									26.1	
24												37.2								22.1
26												34.0					32.8			20.8
28																	30.0			19.2

54105



14.9m-65.6m

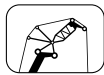

82°/75°/68°
18m

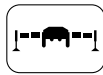

8.9m x 8.53m



360°

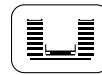

100t

メイン長さ ジブ長さ (m)	14.9m+3.5m			20.0m+3.5m			25.0m+3.5m			30.1m+3.5m			35.2m+3.5m			40.3m+3.5m			45.3m+3.5m			50.4m+3.5m			55.5m+3.5m			60.5m+3.5m			65.6+3.5		
	18m			18m			18m			18m			18m			18m			18m			18m			18m			18m			18m		
角度	82°	75°	68°	82°	75°	68°	82°	75°	68°	82°	75°	68°	82°	75°	68°	82°	75°	68°	82°	75°	68°	82°	75°	68°	82°	75°	68°	82°	75°	68°	82°	75°	68°
9	59.2																																
10	57.9			55.3																													
11	56.5			54.9			49.2																										
12	55.0			53.8			49.1			41.1																							
13	53.7			52.7			49.1			41.1			34.9																				
14	52.5	52.4		51.7			48.6			41.1			34.9			27.1																	
16	50.6	49.1		50.2	49.7		47.5			41.1			34.9			27.0			20.7			15.7											
18	48.2	45.7	46.0	49.6	47.5		46.9	45.7		41.1	39.8		34.9			27.0			20.7			15.6					11.5		8.2				
20	41.0	44.0	42.1	44.1	46.1	44.8	46.5	44.3		41.1	40.0		34.9	33.9		26.9			20.7			15.6					11.5		8.1		5.4		
22		42.3	39.8		42.5	40.7		41.3	38.9	41.1	39.5		34.9	33.8		26.6	24.4		20.7			15.6					11.4		8.1		5.3		
24			38.5			37.2	37.7	35.6		36.5	33.7		33.6			23.2			20.7	18.9		15.6					11.4		8.1		5.3		
26						34.1				32.7	31.0		32.7			22.0				18.1		15.6						11.4		8.1		5.2	
28									30.2							27.4						18.1											
30																25.2						17.3											
32																23.3						16.6											
34																						16.6											
36																						15.7											

54205

起伏式ジブ定格総荷重表 TN

LTM 1400NX

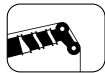

14.9m-65.6m

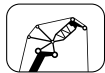

82°/75°/68°
24m

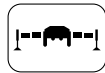

8.9m×8.53m



360°



100t

メインブーム長さ ジブ長さ 角度 作業半径(m)	14.9m+3.5m 24m			20.0m+3.5m 24m			25.0m+3.5m 24m			30.1m+3.5m 24m			35.2m+3.5m 24m			40.3m+3.5m 24m		
	82°	75°	68°	82°	75°	68°	82°	75°	68°	82°	75°	68°	82°	75°	68°	82°	75°	68°
11	46.1																	
12	45.1			42.9														
13	44.2			42.5			38.3											
14	43.3			41.9			38.3			32.5								
16	41.7	41.7		40.6			38.1			32.5			28.0			21.8		
18	40.2	39.8		39.6	39.4		37.3			32.5			28.0			21.7		
20	39.3	38.2		38.8	38.0		36.6	36.2		32.5			28.2			21.6		
22	39.1	36.8	36.6	38.5	36.8		36.3	35.2		32.5	31.6		28.3			21.6		
24	39.1	36.0	34.6	38.5	36.0	35.6	36.3	34.5		32.5	31.2		28.4	27.2		21.6		
26	30.1	35.6	32.9	36.8	35.5	33.9	36.3	34.0	32.4	32.5	30.9		28.4	27.2		21.5	20.0	
28		33.6	32.1		32.8	31.4		31.9	30.0	32.5	30.7	28.2	28.4	27.1		21.3	19.2	
30			30.2			29.1		29.6	27.7		28.5	26.0		27.1	24.8		18.4	
32						27.0			25.7		26.4	24.1		25.6	22.9		17.6	16.0
34									23.8			22.4			21.3		17.0	15.0
36												20.9			19.9		14.2	
38															18.6			13.4

メインブーム長さ ジブ長さ 角度 作業半径(m)	45.3m+3.5m 24m			50.4m+3.5m 24m			55.5m+3.5m 24m			60.5m+3.5m 24m			65.6m+3.5m 24m	
	82°	75°	68°	82°	75°	68°	82°	75°	68°	82°	75°	68°	82°	75°
18	16.6			12.2										
20	16.5			12.2			9.0			6.3				
22	16.5			12.2			9.0			6.2			3.4	
24	16.5			12.2			8.9			6.1			3.4	
26	16.5	15.8		12.2			8.9			6.1			3.4	
28	16.5	15.5		12.2			8.9			6.0			3.3	
30	16.5	15.0		12.2	11.2		8.9			6.0			3.3	
32		14.4			10.8			8.0		6.0			3.3	
34		14.0			10.5			7.8			5.3			
36		13.6	11.9		10.2			7.5			5.3			2.7
38			11.2			8.3		7.3			5.2			2.7
40			10.7			7.8					5.1			2.7
42						7.4			5.3					
44									5.0			3.3		
46												3.2		

54305

起伏式ジブ定格総荷重表 TN

LTM 1400NX



14.9m-65.6m

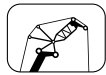

82°/75°/68°
30m

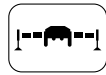

8.9m×8.53m

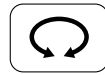

360°

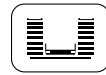

100t

メインブーム長さ ジブ長さ	14.9m+3.5m			20.0m+3.5m			25.0m+3.5m			30.1m+3.5m			35.2m+3.5m			40.3m+3.5m		
角度	30m			30m			30m			30m			30m			30m		
作業半径(m)	82°	75°	68°	82°	75°	68°	82°	75°	68°	82°	75°	68°	82°	75°	68°	82°	75°	68°
13	35.7																	
14	35.1			33.2														
16	34.2			32.9			29.8			25.8								
18	33.2			32.2			29.8			25.7			22.3			17.7		
20	32.4	31.9		31.5	31.2		29.5			25.5			22.2			17.6		
22	31.7	30.9		31.0	30.3		29.2	28.7		25.5			22.2			17.5		
24	31.3	30.1	29.8	30.6	29.6		28.8	28.1		25.5	24.8		22.2			17.4		
26	31.2	29.4	28.8	30.5	29.1	28.7	28.7	27.6		25.5	24.8		22.2	21.4		17.4		
28	31.2	29.0	28.0	30.5	28.6	27.9	28.7	27.2	26.9	25.5	24.7		22.2	21.4		17.4	16.7	
30	27.9	29.0	27.3	30.5	28.5	27.3	28.7	27.0	26.3	25.5	24.5		22.2	21.4		17.4	16.3	
32	20.9	29.0	27.1	25.9	28.2	26.7	28.7	26.9	25.4	25.5	24.4	23.7	22.2	21.4		17.4	15.9	
34		24.2	26.0		26.3	24.9		25.4	23.6	25.5	24.3	22.0	22.2	21.4	20.7	17.4	15.4	
36			24.2			23.2		23.7	22.0		22.7	20.5		21.4	19.6		14.9	13.3
38						21.7			20.6		21.2	19.2		20.6	18.4		14.5	12.6
40									19.3			18.0			17.2		14.1	12.0
42												16.9			16.2			11.5
44															15.2			11.0

メインブーム長さ ジブ長さ	45.3m+3.5m			50.4m+3.5m			55.5m+3.5m			60.5m+3.5m			65.6+3.5
角度	30m			30m			30m			30m			30m
作業半径(m)	82°	75°	68°	82°	75°	68°	82°	75°	68°	82°	75°	68°	82°
20	13.1			10.1									
22	13.1			10.0			7.1			4.3			
24	13.0			9.9			7.1			4.2			1.8
26	13.0			9.9			7.0			4.1			1.8
28	13.0			9.8			7.0			4.1			1.8
30	13.0	12.6		9.8			6.9			4.0			1.7
32	13.0	12.5		9.8	9.3		6.9			4.0			1.7
34	13.0	12.3		9.8	9.1		6.9	6.3		4.0			1.7
36	13.0	11.9		9.8	8.8		6.9	6.2		4.0	3.4		1.7
38		11.6	10.3		8.6			6.2		4.0	3.4		1.7
40		11.3	9.8		8.3			6.0			3.4		
42		11.1	9.4		8.1	6.7		5.8			3.3		
44			8.9			6.4		5.7	4.4		3.3		
46			8.6			6.1			4.1		3.3		
48						5.8			3.9			2.5	
50									3.7			2.4	
52												2.2	

54405

起伏式ジブ定格総荷重表 TN

LTM 1400NX

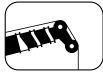

14.9m-60.5m

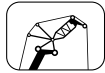

82°/75°/68°
36m

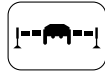

8.9m×8.53m



360°

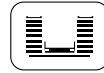

100t

メインブーム長さ ジブ長さ 角度 作業半径(m)	14.9m+3.5m 36m			20.0m+3.5m 36m			25.0m+3.5m 36m			30.1m+3.5m 36m			35.2m+3.5m 36m		
	82°	75°	68°	82°	75°	68°	82°	75°	68°	82°	75°	68°	82°	75°	68°
16	28.0			26.1											
18	27.4			25.9			23.6			20.6			18.1		
20	26.8			25.8			23.4			20.5			17.9		
22	26.2	25.9		25.4			23.3			20.4			17.8		
24	25.7	25.2		25.0	24.6		23.3	22.8		20.3			17.8		
26	25.2	24.6		24.6	24.1		23.2	22.7		20.3	19.7		17.8		
28	24.9	24.1	23.8	24.4	23.6		23.0	22.4		20.3	19.6		17.8	17.2	
30	24.2	23.6	23.1	24.1	23.3	23.0	22.7	22.1		20.3	19.6		17.8	17.2	
32	23.3	23.3	22.6	23.2	22.9	22.4	22.1	21.8	21.5	20.3	19.6		17.8	17.1	
34	22.3	22.8	22.1	22.3	22.8	22.0	21.3	21.6	21.1	20.2	19.6	19.2	17.8	17.1	
36	21.3	22.2	21.9	21.4	22.2	21.7	20.5	21.5	20.7	19.9	19.6	19.0	17.8	17.1	16.7
38		21.3	21.7	20.7	21.5	21.5	19.8	20.8	20.4	19.3	19.6	18.8	17.8	17.1	16.8
40		19.9	21.1		20.7	20.2		20.1	19.2	19.0	19.5	17.8	17.8	17.1	16.9
42			19.9			19.0		19.5	18.0		18.6	16.8		17.1	15.9
44						17.9			17.0		17.5	15.8		16.9	14.9
46									16.0			14.9			14.1
48												14.1			13.3
50															12.6

メインブーム長さ ジブ長さ 角度 作業半径(m)	40.3m+3.5m 36m			45.3m+3.5m 36m			50.4m+3.5m 36m			55.5m+3.5m 36m			60.5m+3.5m 36m		
	82°	75°	68°	82°	75°	68°	82°	75°	68°	82°	75°	68°	82°	75°	68°
20	14.4														
22	14.3			10.5			8.1								
24	14.3			10.4			8.0			5.2			2.7		
26	14.2			10.4			8.0			5.1			2.6		
28	14.2			10.3			8.0			5.1			2.5		
30	14.2	13.7		10.3			7.9			5.0			2.5		
32	14.2	13.6		10.3	10.0		7.9			5.0			2.5		
34	14.2	13.5		10.3	10.0		7.9	7.4		4.9			2.4		
36	14.2	13.2		10.3	10.1		7.9	7.3		4.9	4.4		2.4		
38	14.2	13.0		10.3	10.0		7.9	7.3		4.9	4.3		2.4	1.9	
40	14.2	12.6	11.3	10.3	9.8		7.9	7.2		4.9	4.3		2.4	1.9	
42		12.3	10.8	10.3	9.6	8.5	7.9	7.0		4.9	4.3		2.4	1.9	
44		12.0	10.3		9.4	8.2		6.9			4.3		2.4	1.8	
46		11.8	9.9		9.2	7.8		6.7	5.5		4.3			1.8	
48			9.5		9.1	7.5		6.5	5.2		4.3	3.4		1.8	
50			9.1			7.2			5.0		4.3	3.2		1.8	
52						7.0			4.7			3.0		1.8	1.6
54									4.5			2.9			1.6
56												2.7			1.6
58															1.4

54505

起伏式ジブ定格総荷重表 TN

LTM 1400NX

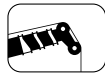

14.9m—55.5m

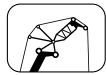

82°/75°/68°
42m

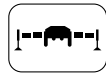

8.9m×8.53m

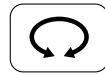

360°

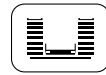

100t

メイン長さ ジブ長さ (m)	14.9m+3.5m			20.0m+3.5m			25.0m+3.5m			30.1m+3.5m			35.2m+3.5m			40.3m+3.5m			45.3m+3.5m			50.4m+3.5m			55.5m+3.5m			
	42m			42m			42m			42m			42m			42m			42m			42m			42m			
	82°	75°	68°	82°	75°	68°	82°	75°	68°	82°	75°	68°	82°	75°	68°	82°	75°	68°	82°	75°	68°	82°	75°	68°	82°	75°	68°	
18	22.1			20.9																								
20	22.1			20.7			19.0			16.6			14.7															
22	21.7			20.5			18.9			16.5			14.5			11.8		8.5										
24	21.3	21.2		20.4			18.7			16.4			14.4			11.7		8.5			6.3							
26	20.9	20.7		20.3	20.0		18.5			16.3			14.4			11.6		8.4			6.2			3.5				
28	20.4	20.2		19.9	19.7		18.5	18.1		16.3	15.9		14.3			11.6		8.4			6.1			3.5				
30	19.8	19.8		19.6	19.3		18.5	18.1		16.3	15.8		14.3	13.9		11.6		8.3			6.0			3.4				
32	18.9	19.2	19.2	18.8	19.0		18.3	18.0		16.2	15.7		14.3	13.9		11.6	11.1	8.3			5.9			3.4				
34	18.0	18.7	18.7	18.0	18.6	18.5	17.7	17.8		16.2	15.7		14.3	13.8		11.6	11.1	8.3	8.0		5.9			3.3				
36	17.1	17.9	18.3	17.2	18.1	18.2	17.0	17.6	17.4	16.2	15.7		14.3	13.8		11.6	11.1	8.3	8.0		5.8	5.4		3.3				
38	16.3	17.0	17.7	16.4	17.3	17.8	16.3	17.3	17.1	15.8	15.7	15.4	14.3	13.8		11.6	11.0	8.3	8.0		5.8	5.3		3.2	2.8			
40	15.6	16.3	16.9	15.6	16.5	17.3	15.6	16.6	16.9	15.3	15.7	15.4	14.3	13.8	13.4	11.6	10.9	8.3	8.0		5.7	5.3		3.2	2.8			
42	14.9	15.5	16.2	15.0	15.8	16.6	15.0	15.9	16.6	14.8	15.6	15.3	14.3	13.8	13.4	11.6	10.8	9.9	8.3	8.0		5.7	5.2		3.2	2.7		
44		14.9	15.4	14.5	15.1	15.9	14.5	15.3	16.2	14.3	15.1	15.2	13.9	13.8	13.4	11.6	10.6	9.5	8.3	8.0		5.7	5.2		3.2	2.7		
46		14.4	14.8		14.6	15.2		14.7	15.5		14.6	14.6	13.6	13.8	13.4	11.6	10.4	9.1	8.3	8.0	7.1	5.7	5.2		3.2	2.7		
48			14.3		14.6		14.2	14.9		14.2	13.8		13.8	13.0		10.1	8.8	8.3	7.9	6.8	5.7	5.2	4.6	3.2	2.7			
50					14.2			14.1		13.8	13.1		13.6	12.3		9.9	8.4		7.7	6.6		5.2	4.4		2.7			
52								13.4					12.4			11.7		9.8	8.1		7.6	6.3		5.2	4.2		2.7	2.5
54												11.8				11.1		7.8		7.6	6.1		5.2	4.0		2.7	2.5	
56																	7.6			5.9			3.8		2.7	2.3		
58																				5.7				3.6		2.2		
60																								3.5			2.1	
62																											2.0	

54605

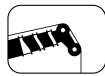

14.9m—55.5m

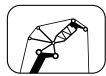

82°/75°/68°
48m

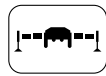

8.9m×8.53m

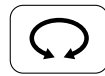

360°



100t

メイン長さ ジブ長さ (m)	14.9m+3.5m			20.0m+3.5m			25.0m+3.5m			30.1m+3.5m			35.2m+3.5m			40.3m+3.5m			45.3m+3.5m			50.4m+3.5m			55.5m+3.5m		
	48m			48m			48m			48m			48m			48m			48m			48m			48m		
	82°	75°	68°	82°	75°	68°	82°	75°	68°	82°	75°	68°	82°	75°	68°	82°	75°	68°	82°	75°	68°	82°	75°	68°	82°	75°	68°
20	17.8			16.8			15.5																				
22	17.5			16.6			15.3			13.5			11.9														
24	17.5			16.5			15.2			13.3			11.8			9.6		6.9									
26	17.3			16.3			15.1			13.2			11.7			9.6		6.8			4.7					2.4	
28	17.1	17.0		16.2	15.9		15.0			13.2			11.6			9.6		6.7			4.6					2.3	
30	16.9	16.6		16.1	15.8		14.9	14.6		13.1			11.6			9.5		6.7			4.6					2.3	
32	16.6	16.3		16.1	15.8		14.9	14.5		13.1	12.8		11.6			9.5		6.7			4.5					2.2	
34	16.4	16.0	15.8	16.0	15.7		14.9	14.4		13.1	12.7		11.6	11.2		9.5		6.7			4.4					2.2	
36	16.3	15.8	15.6	15.9	15.5	15.2	14.8	14.4		13.1	12.7		11.6	11.2		9.5	9.1		6.6			4.4				2.1	
38	16.2	15.6	15.3	15.8	15.3	15.0	14.8	14.4	14.1	13.1	12.6		11.6	11.2		9.5	9.1		6.6	6.3		4.3				2.1	
40	16.2	15.4	15.0	15.8	15.1	14.8	14.8	14.3	14.1	13.1	12.6	12.3	11.6	11.2		9.5	9.1		6.6	6.3		4.3	3.9			2.1	
42	16.2	15.3	14.8	15.8	15.0	14.6	14.8	14.3	13.9	13.1	12.6	12.3	11.6	11.2		9.5	9.0		6.6	6.2		4.2	3.8			2.1	1.6
44	16.2	15.3	14.7	15.8	14.9	14.4	14.8	14.2	13.8	13.1	12.6	12.3	11.6	11.1	10.8	9.5	9.0		6.6	6.2		4.2	3.8			2.1	1.6
46	15.9	15.3	14.5	15.8	14.9	14.3	14.8	14.2	13.7	13.1	12.6	12.3	11.6	11.1	10.8	9.5	8.9	8.3	6.6	6.2		4.2	3.8			2.1	1.6
48	14.7	15.3	14.5	15.8	14.9	14.2	14.8	14.2	13.6	13.1	12.6	12.3	11.6	11.1	10.8	9.5	8.8	8.0	6.6	6.2	5.9	4.2	3.8			2.1	1.6
50		15.3	14.5	14.2	14.9	14.2	14.8	14.2	13.5	13.1	12.6	12.3	11.6	11.1	10.8	9.5	8.7	7.7	6.6	6.2	5.8	4.2	3.8			2.1	1.6
52		13.3	14.5		14.9	14.0		14.2	13.2		12.6	12.1	11.6	11.1	10.8	9.5	8.6	7.4	6.6	6.2	5.6	4.2	3.8	3.6	2.1	1.6	
54			14.0			13.3		13.7	12.5		12.6	11.5		11.1	10.8		8.4	7.2		6.2	5.4	4.2	3.8	3.5	2.1	1.6	
56						12.6			11.9		12.3	10.9		11.1	10.4		8.3	6.9		6.2	5.2		3.8	3.3		1.6	1.5
58									11.3			10.4			9.8		8.2	6.7		6.2	5.1		3.8	3.1		1.6	1.6
60											9.9				9.4			6.4		6.2	4.9		3.8	3.0		1.6	1.6
62																			6.2							1.6	1.6
64																					4.5						1.5
66																											1.4
68																											1.2

54705

起伏式ジブ定格総荷重表 TN

LTM 1400NX



14.9m-50.4m

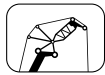

82°/75°/68°
54m

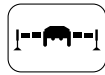

8.9m×8.53m

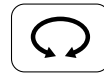

360°

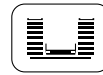

100t

メイン長さ ジブ長さ (m)	14.9m+3.5m			20.0m+3.5m			25.0m+3.5m			30.1m+3.5m			35.2m+3.5m			40.3m+3.5m			45.3m+3.5m			50.4m+3.5m		
	54m			54m			54m			54m			54m			54m			54m			54m		
角度	82°	75°	68°	82°	75°	68°	82°	75°	68°	82°	75°	68°	82°	75°	68°	82°	75°	68°	82°	75°	68°	82°	75°	68°
22	14.4			13.6			12.2																	
24	14.2			13.4			12.2			10.9			9.7											
26	14.0			13.3			12.2			10.8			9.6			7.8			5.3					
28	13.9			13.2			12.1			10.7			9.5			7.8			5.2			3.1		
30	13.8	13.6		13.0			12.1			10.6			9.4			7.7			5.1			3.0		
32	13.7	13.6		12.9	12.7		12.0	11.8		10.6			9.4			7.7			5.1			2.9		
34	13.6	13.4		12.9	12.6		11.9	11.7		10.6	10.3		9.3			7.6			5.0			2.9		
36	13.4	13.2		12.9	12.6		11.8	11.6		10.5	10.3		9.3	9.0		7.6			4.9			2.8		
38	13.3	13.0	12.7	12.9	12.6		11.8	11.5		10.5	10.2		9.3	9.0		7.5	7.1		4.9			2.8		
40	13.2	12.8	12.6	12.8	12.5	12.3	11.8	11.5		10.5	10.2		9.3	9.0		7.4	7.1		4.8	4.5		2.7		
42	13.1	12.6	12.4	12.8	12.4	12.2	11.8	11.5	11.2	10.5	10.1		9.3	9.0		7.3	7.0		4.7	4.4		2.7	2.3	
44	13.1	12.5	12.2	12.7	12.2	12.0	11.8	11.5	11.3	10.5	10.1	9.9	9.3	9.0		7.3	7.0		4.7	4.4		2.7	2.3	
46	13.1	12.4	12.0	12.7	12.2	11.8	11.8	11.5	11.2	10.5	10.1	9.8	9.3	9.0	8.7	7.3	7.0		4.7	4.4		2.7	2.3	
48	13.1	12.3	11.8	12.7	12.1	11.7	11.8	11.5	11.1	10.5	10.1	9.8	9.3	9.0	8.7	7.3	7.0		4.7	4.4		2.7	2.3	
50	13.1	12.3	11.8	12.7	12.1	11.6	11.8	11.5	11.0	10.5	10.1	9.8	9.3	9.0	8.7	7.3	7.0	6.7	4.7	4.4		2.7	2.3	
52	13.1	12.3	11.7	12.7	12.1	11.5	11.8	11.5	11.0	10.5	10.1	9.8	9.3	9.0	8.6	7.3	7.0	6.6	4.7	4.4	4.3	2.7	2.3	
54	12.1	12.3	11.7	12.7	12.1	11.5	11.8	11.5	10.9	10.5	10.1	9.8	9.3	9.0	8.6	7.3	7.0	6.4	4.7	4.4	4.4	2.7	2.3	
56		12.3	11.7	11.6	12.1	11.5	11.7	11.5	10.9	10.5	10.1	9.8	9.3	9.0	8.6	7.3	7.0	6.1	4.7	4.4	4.4	2.7	2.3	2.3
58		11.2	11.7		12.1	11.5		11.5	10.9		10.1	9.8	9.3	9.0	8.6	7.3	7.0	5.9	4.7	4.4	4.3	2.7	2.3	2.3
60			11.7			11.2		11.5	10.5		10.1	9.6		9.0	8.6		6.9	5.7		4.4	4.1	2.7	2.3	2.4
62						10.6				10.0		9.2		9.0	8.6		6.8	5.5		4.4	4.0		2.3	2.3
64												9.5			8.7								2.3	2.2
66													8.3			7.7							2.3	2.1
68																		4.9						2.0
70																						3.4		1.9
72																								1.8

54805

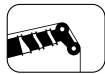

14.9m-50.4m

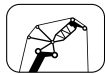

82°/75°/68°
60m

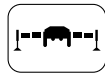

8.9m×8.53m



360°



100t

メイン長さ ジブ長さ (m)	14.9m+3.5m			20.0m+3.5m			25.0m+3.5m			30.1m+3.5m			35.2m+3.5m			40.3m+3.5m			45.3m+3.5m			50.4+3.5	
	60m			60m			60m			60m			60m			60m			60m			60m	
角度	82°	75°	68°	82°	75°	68°	82°	75°	68°	82°	75°	68°	82°	75°	68°	82°	75°	68°	82°	75°	68°	82°	
24	11.4			10.8			10.1																
26	11.3			10.7			9.9			8.8			7.7										
28	11.1			10.6			9.8			8.7			7.7			5.8			3.4				
30	11.0			10.5			9.7			8.6			7.6			5.7			3.3				1.5
32	10.9	10.8		10.4			9.6			8.5			7.5			5.6			3.3				1.4
34	10.8	10.7		10.3	10.2		9.6			8.5			7.5			5.5			3.2				1.4
36	10.7	10.6		10.2	10.1		9.5	9.3		8.4	8.2		7.4			5.5			3.2				1.4
38	10.7	10.6		10.2	10.0		9.4	9.3		8.4	8.2		7.4	7.2		5.4			3.1				1.3
40	10.6	10.4	10.2	10.1	9.9		9.4	9.2		8.4	8.1		7.4	7.2		5.3	5.0		3.1				1.3
42	10.5	10.3	10.1	10.0	9.8	9.7	9.3	9.1		8.3	8.1		7.4	7.1		5.3	4.9		3.0	2.7			1.3
44	10.5	10.2	10.0	10.0	9.8	9.7	9.3	9.0		8.3	8.1		7.3	7.1		5.3	4.9		3.0	2.7			1.3
46	10.4	10.1	9.9	10.0	9.8	9.7	9.3	9.0	8.9	8.3	8.0		7.3	7.1		5.2	4.9		3.0	2.7			1.3
48	10.4	10.0	9.7	10.0	9.7	9.6	9.3	9.0	8.8	8.3	8.0	7.8	7.3	7.1		5.2	4.9		3.0	2.7			1.3
50	10.4	9.9	9.6	10.0	9.7	9.4	9.3	9.0	8.8	8.3	8.0	7.8	7.3	7.1	6.9	5.2	4.9		3.0	2.7			1.3
52	10.3	9.9	9.4	9.9	9.7	9.4	9.3	9.0	8.8	8.3	8.0	7.8	7.3	7.1	6.9	5.2	4.9	4.9	3.0	2.7			1.3
54	10.3	9.9	9.4	9.9	9.6	9.3	9.3	9.0	8.8	8.3	8.0	7.7	7.3	7.1	6.8	5.2	4.9	4.9	3.0	2.7			1.3
56	10.3	9.9	9.3	9.9	9.6	9.2	9.3	9.0	8.8	8.3	8.0	7.7	7.3	7.1	6.8	5.2	4.9	5.0	3.0	2.7	2.7		1.3
58	10.3	9.9	9.3	9.9	9.6	9.2	9.3	9.0	8.8	8.3	8.0	7.7	7.3	7.1	6.8	5.2	4.9	5.0	3.0	2.7	2.8		1.3
60	9.4	9.9	9.3	9.9	9.6	9.2	9.3	9.0	8.8	8.3	8.0	7.7	7.3	7.1	6.8	5.2	4.9	5.0	3.0	2.7	2.9		1.3
62		9.9	9.3	9.2	9.6	9.2	9.3	9.0	8.8	8.3	8.0	7.7	7.3	7.1	6.8	5.2	4.9	4.8	3.0	2.7	3.0		1.3
64		8.9	9.3		9.6	9.2		9.0	8.8		8.0	7.7	7.3	7.1	6.8	5.2	4.9	4.7	3.0	2.7	3.0		1.3
66			9.3			9.2		9.0	8.8		8.0	7.7		7.1	6.8		4.9	4.5		2.7	3.0		1.3
68						9.0			8.4		8.0	7.6		7.1	6.8		4.9	4.3		2.7	3.0		
70									8.0			7.3			6.7		4.9	4.1		2.7	2.8		
72													6.9			6.4				3.9		2.7	2.7
74																						2.6	
76																							2.5

54905

起伏式ジブ定格総荷重表 TN

LTM 1400NX



14.9m-45.3m

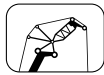

82°/75°/68°
66m

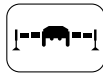

8.9m×8.53m

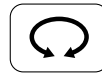

360°

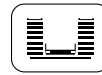

100t

メインブーム長さ ジブ長さ	14.9m+3.5m			20.0m+3.5m			25.0m+3.5m			30.1m+3.5m			35.2m+3.5m			40.3m+3.5m			45.3m+3.5m		
角度	66m			66m			66m			66m			66m			66m			66m		
作業半径(m)	82°	75°	68°	82°	75°	68°	82°	75°	68°	82°	75°	68°	82°	75°	68°	82°	75°	68°	82°	75°	68°
26	9.2			8.8			8.1														
28	9.1			8.6			8.0			7.1			6.1								
30	9.0			8.5			7.9			7.0			6.1			4.1				2.0	
32	8.9			8.4			7.8			6.9			6.0			4.0				1.9	
34	8.8	8.7		8.4			7.7			6.8			5.9			3.9				1.9	
36	8.7	8.6		8.3	8.2		7.7			6.8			5.8			3.8				1.8	
38	8.6	8.5		8.2	8.1		7.6	7.5		6.7			5.7			3.8				1.7	
40	8.6	8.4		8.1	8.0		7.6	7.4		6.6	6.5		5.6	5.4		3.7				1.7	
42	8.5	8.4		8.1	7.9		7.5	7.4		6.6	6.5		5.6	5.3		3.7	3.4			1.7	
44	8.5	8.3	8.1	8.0	7.8		7.5	7.3		6.6	6.4		5.6	5.3		3.7	3.3			1.6	1.4
46	8.4	8.2	8.1	7.9	7.8	7.7	7.4	7.2		6.6	6.4		5.6	5.3		3.7	3.3			1.6	1.4
48	8.4	8.2	8.0	7.9	7.8	7.6	7.4	7.2	7.1	6.6	6.4		5.6	5.3		3.7	3.3			1.6	1.4
50	8.3	8.1	7.9	7.9	7.8	7.6	7.4	7.2	7.0	6.6	6.4	6.2	5.6	5.3		3.7	3.3			1.6	1.5
52	8.3	8.0	7.8	7.9	7.8	7.6	7.3	7.1	7.0	6.6	6.3	6.2	5.6	5.3	5.3	3.7	3.3			1.6	1.5
54	8.3	7.9	7.7	7.9	7.7	7.6	7.3	7.1	6.9	6.6	6.3	6.1	5.6	5.3	5.3	3.7	3.3			1.6	1.6
56	8.2	7.9	7.7	7.9	7.7	7.5	7.3	7.1	6.9	6.6	6.3	6.1	5.6	5.3	5.3	3.7	3.3	3.4		1.6	1.6
58	8.2	7.9	7.6	7.9	7.7	7.5	7.3	7.1	6.9	6.6	6.3	6.1	5.6	5.3	5.3	3.7	3.3	3.4	1.6	1.7	1.4
60	8.2	7.9	7.5	7.9	7.7	7.4	7.3	7.1	6.9	6.6	6.3	6.1	5.6	5.3	5.3	3.7	3.3	3.4	1.6	1.7	1.5
62	8.2	7.9	7.5	7.9	7.7	7.4	7.3	7.1	6.9	6.6	6.3	6.1	5.6	5.3	5.3	3.7	3.3	3.4	1.6	1.7	1.5
64	8.2	7.9	7.5	7.9	7.7	7.4	7.3	7.1	6.9	6.6	6.3	6.1	5.6	5.3	5.3	3.7	3.3	3.4	1.6	1.7	1.6
66		7.9	7.5	7.9	7.7	7.4	7.3	7.1	6.9	6.6	6.3	6.1	5.6	5.3	5.3	3.7	3.3	3.4	1.6	1.7	1.7
68		7.9	7.5	7.7	7.7	7.4	7.3	7.1	6.9	6.6	6.3	6.1	5.6	5.3	5.3	3.7	3.3	3.4	1.6	1.7	1.7
70		7.6	7.5	7.7	7.7	7.4	7.3	7.1	6.9	6.6	6.3	6.1	5.6	5.3	5.3	3.7	3.3	3.4	1.6	1.7	1.7
72			7.5		7.7	7.4	7.3	7.1	6.9	6.6	6.3	6.1	5.6	5.3	5.3	3.7	3.3	3.4		1.7	1.7
74					7.4		7.1	6.9	6.9	6.6	6.3	6.1	5.6	5.3	5.3	3.7	3.3	3.3		1.7	1.7
76					7.4		7.1	6.9	6.9	6.6	6.3	6.1	5.6	5.3	5.3	3.7	3.3	3.3		1.7	1.7
78							6.7	6.9	6.9	6.6	6.3	6.1	6.0		5.3	5.3	3.7	3.1		1.7	1.7
80															5.2		3.0			1.7	1.7
82																	2.9				1.7

55005



14.9m-40.3m

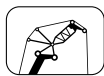

82°/75°/68°
72m

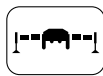

8.9m×8.53m



360°



100t

メインブーム長さ ジブ長さ	14.9m+3.5m			20.0m+3.5m			25.0m+3.5m			30.1m+3.5m			35.2m+3.5m			40.3m+3.5m					
角度	72m			72m			72m			72m			72m			72m					
作業半径(m)	82°	75°	68°	82°	75°	68°	82°	75°	68°	82°	75°	68°	82°	75°	68°	82°	75°	68°			
26	7.2																				
28	7.2			6.8			6.3														
30	7.2			6.8			6.3			5.5			4.6								
32	7.1			6.7			6.2			5.5			4.5						2.7		
34	7.0			6.6			6.1			5.4			4.4						2.7		
36	6.9			6.5			6.0			5.3			4.3						2.6		
38	6.8	6.6		6.5	6.2		6.0			5.3			4.2						2.5		
40	6.7	6.6		6.4	6.2		5.9	5.7		5.2			4.1						2.5		
42	6.6	6.6		6.3	6.2		5.8	5.8		5.2	5.0		4.0						2.4		
44	6.6	6.5		6.3	6.2		5.8	5.7		5.1	5.0		4.0	3.8					2.4		
46	6.5	6.4		6.2	6.1		5.8	5.7		5.1	4.9		4.0	3.9					2.4		
48	6.4	6.4	6.1	6.1	6.0		5.7	5.6		5.1	4.9		4.0	3.9					2.4	2.2	
50	6.4	6.3	6.2	6.1	6.0	5.8	5.7	5.6		5.0	4.9		4.0	3.9					2.4	2.2	
52	6.4	6.3	6.2	6.1	5.9	5.8	5.7	5.5	5.3	5.0	4.9		4.0	3.9					2.4	2.3	
54	6.4	6.2	6.1	6.0	5.9	5.8	5.6	5.5	5.4	5.0	4.8	4.7	4.0	3.9					2.4	2.3	
56	6.4	6.2	6.1	6.0	5.9	5.8	5.6	5.5	5.3	5.0	4.8	4.7	4.0	3.9	3.9				2.4	2.4	
58	6.4	6.1	6.0	6.0	5.9	5.8	5.6	5.4	5.3	5.0	4.8	4.7	4.0	3.9	3.9	3.9			2.4	2.4	2.2
60	6.4	6.1	5.9	6.0	5.9	5.8	5.6	5.4	5.3	5.0	4.8	4.6	4.0	3.9	3.9	3.9			2.4	2.4	2.3
62	6.3	6.1	5.9	6.0	5.9	5.7	5.6	5.4	5.3	5.0	4.7	4.6	4.0	3.9	3.9	3.9			2.4	2.4	2.3
64	6.3	6.1	5.8	6.0	5.9	5.7	5.6	5.4	5.3	5.0	4.7	4.6	4.0	3.9	3.9	3.9			2.4	2.5	2.4
66	6.3	6.1	5.8	6.0	5.9	5.7	5.6	5.4	5.3	5.0	4.7	4.5	4.0	3.9	3.9	3.9			2.4	2.4	2.4
68	6.3	6.1	5.8	6.0	5.9	5.7	5.6	5.4	5.3	5.0	4.7	4.5	4.0	3.9	3.9	3.9			2.4	2.4	2.5
70	6.3	6.1	5.8	6.0	5.9	5.7	5.6	5.4	5.3	5.0	4.7	4.5	4.0	3.9	3.9	3.9			2.4	2.4	2.4
72	6.3	6.1	5.8	6.0	5.9	5.7	5.6	5.4	5.3	5.0	4.7	4.5	4.0	3.9	3.9	3.9			2.4	2.4	2.4
74		6.1	5.8	5.8	5.9	5.7	5.6	5.4	5.3	5.0	4.7	4.5	4.0	3.9	3.9	3.9			2.4	2.4	2.4
76		6.1	5.8		5.9	5.7	5.6	5.4	5.3		4.7	4.5	4.0	3.9	3.9	3.9			2.4	2.4	2.4
78			5.8			5.7	5.6	5.4	5.3		4.7	4.5	4.0	3.9	3.9	3.9			2.4	2.4	2.4
80						5.7	5.6	5.4	5.3		4.7	4.5	4.0	3.9	3.9	3.9			2.4	2.4	2.4
82						5.7	5.6	5.4	5.3		4.7	4.5	4.0	3.9	3.9	3.9			2.4	2.4	2.4
84							5.3	5.3	5.3		4.7	4.5	4.0	3.9	3.9	3.9			2.4	2.3	2.2
86													4.5	4.5	4.5	4.5				2.1	2.1

55105

起伏式ジブ定格総荷重表 TN

LTM 1400NX

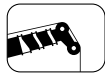

14.9m-35.2m

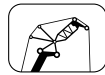

82°/75°/68°
78m

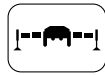

8.9m×8.53m



360°

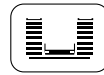

100t

メインブーム長さ ジブ長さ 角度 作業半径(m)	14.9m+3.5m 78m			20.0m+3.5m 78m			25.0m+3.5m 78m			30.1m+3.5m 78m			35.2m+3.5m 78m		
	82°	75°	68°	82°	75°	68°	82°	75°	68°	82°	75°	68°	82°	75°	68°
28	5.7														
30	5.7			5.3			4.9								
32	5.6			5.3			4.9			4.0			3.0		
34	5.6			5.3			4.8			3.9			2.9		
36	5.5			5.2			4.8			3.9			2.8		
38	5.4			5.1			4.7			3.8			2.7		
40	5.3	5.1		5.0			4.6			3.7			2.7		
42	5.2	5.1		5.0	4.8		4.6	4.3		3.6			2.6		
44	5.2	5.1		4.9	4.8		4.5	4.3		3.6	3.4		2.6		
46	5.1	5.0		4.8	4.8		4.5	4.3		3.6	3.5		2.6	2.4	
48	5.0	5.0		4.8	4.7		4.4	4.3		3.6	3.5		2.6	2.5	
50	5.0	4.9	4.5	4.7	4.7		4.4	4.3		3.6	3.5		2.6	2.5	
52	4.9	4.8	4.6	4.7	4.6	4.2	4.3	4.2		3.6	3.6		2.6	2.5	
54	4.9	4.8	4.7	4.7	4.6	4.3	4.3	4.2	3.8	3.6	3.6		2.6	2.6	
56	4.9	4.8	4.7	4.6	4.5	4.4	4.3	4.2		3.6	3.5	3.3	2.6	2.6	
58	4.8	4.8	4.7	4.6	4.5	4.4	4.3	4.1	3.9	3.6	3.5	3.4	2.6	2.6	
60	4.8	4.7	4.7	4.6	4.4	4.3	4.3	4.1	3.9	3.6	3.5	3.4	2.6	2.6	2.5
62	4.8	4.7	4.6	4.6	4.4	4.3	4.2	4.0	3.9	3.6	3.5	3.4	2.6	2.7	2.6
64	4.8	4.7	4.5	4.6	4.4	4.3	4.2	4.0	3.9	3.6	3.5	3.4	2.6	2.7	2.6
66	4.8	4.6	4.4	4.6	4.4	4.3	4.2	4.0	3.9	3.6	3.5	3.4	2.6	2.7	2.7
68	4.8	4.6	4.4	4.6	4.4	4.3	4.2	4.0	3.9	3.6	3.5	3.4	2.6	2.7	2.6
70	4.7	4.6	4.4	4.5	4.4	4.3	4.2	4.0	3.9	3.6	3.5	3.4	2.6	2.6	2.6
72	4.7	4.6	4.4	4.5	4.4	4.3	4.2	4.0	3.9	3.6	3.5	3.3	2.6	2.6	2.6
74	4.7	4.6	4.4	4.5	4.4	4.3	4.2	4.0	3.9	3.6	3.5	3.3	2.6	2.6	2.6
76	4.7	4.6	4.4	4.5	4.4	4.3	4.2	4.0	3.9	3.6	3.5	3.3	2.6	2.6	2.6
78	4.7	4.6	4.4	4.5	4.4	4.3	4.2	4.0	3.9	3.6	3.5	3.3	2.6	2.6	2.6
80		4.6	4.4		4.4	4.3	4.2	4.0	3.9	3.6	3.5	3.3	2.6	2.6	2.6
82		4.6	4.4		4.4	4.3	4.2	4.0	3.9	3.6	3.5	3.3	2.6	2.6	2.6
84			4.4			4.3		4.0	3.9		3.5	3.3		2.6	2.6
86						4.3			3.9		3.5	3.3		2.6	2.6
88									3.9			3.3			2.6
90															2.6

55205

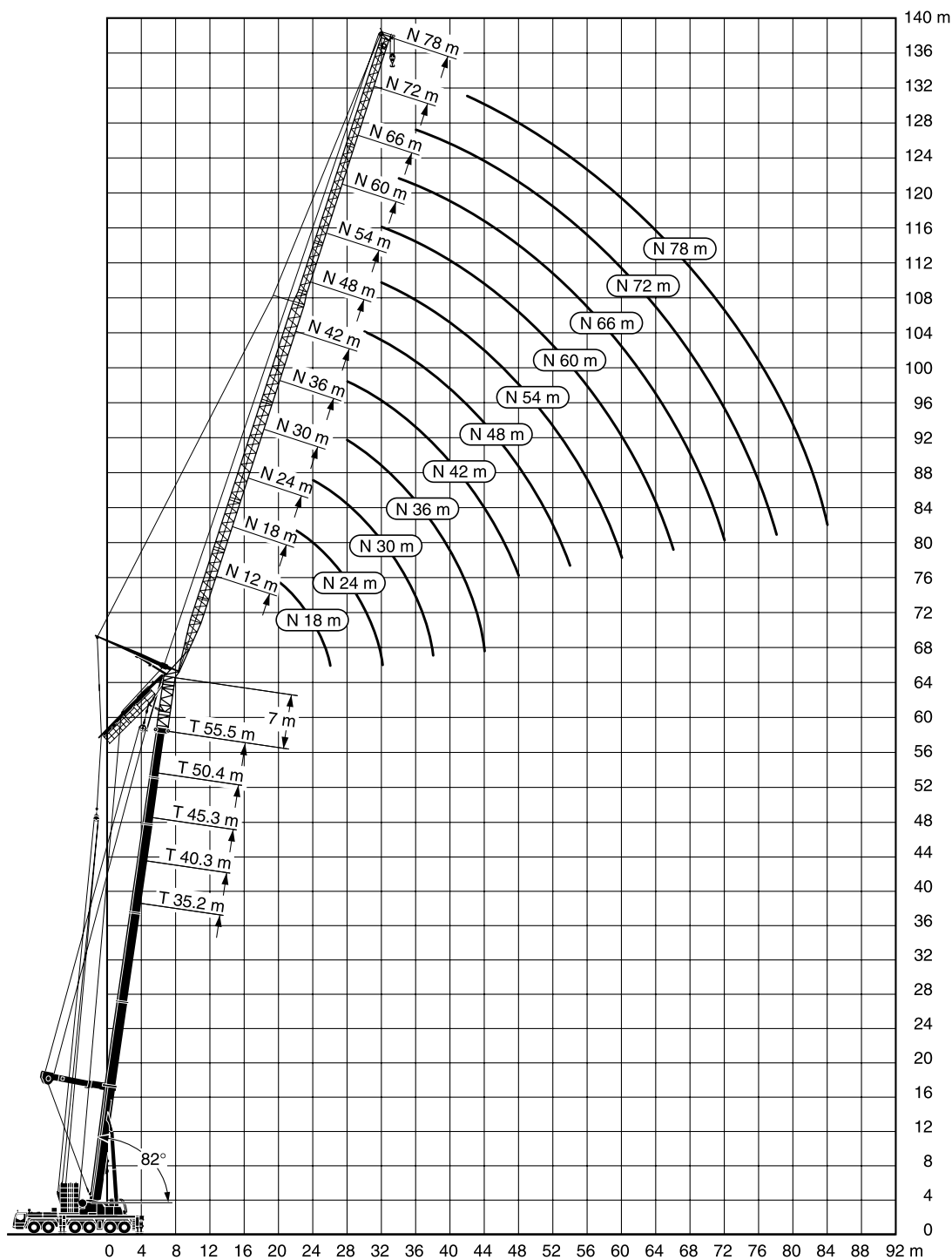









注意

- 1 定格総荷重はフックブロック、玉掛ワイヤー等の自重を含みます。
また、下記の条件が考慮されていませんのでクレーンの操作には充分気をつけてください。
 - ① 地盤の強度、地震による影響
 - ② 作業速度に応じた動荷重および台風または強風による影響等
- 2 本機は水平に設置して、クレーン作業を行ってください。
- 3 作業半径は、クレーンの旋回中心から荷重の重心までの水平距離です。
- 4 メインブームの定格総荷重は補助ジブを取り除いた状態での値です。
- 5 メインブーム70m仕様で200トンを超える定格総荷重の場合は、特殊吊装置が必要です。









起伏式ジブ (ガイ、エクセンダー仕様) 定格総荷重表 TYVEN

LTM 1400NX

 35.2m-65.6m
 
 3.5m
 
 E
 
 82°/75°/68° 30m
 
 8.9m x 8.53m
 
 360°
 
 140t
 
Y-ガイ

メインブーム長さ ジブ長さ	35.2m+7m 30m			40.3m+7m 30m			45.3m+7m 30m			50.4m+7m 30m			55.5m+7m 30m			60.5m+7m 30m			65.6m+7m 30m					
	角度	82°	75°	68°	82°	75°	68°	82°	75°	68°	82°	75°	68°	82°	75°	68°	82°	75°	68°	82°	75°	68°		
作業半径(m)																								
18	26.5																							
20	27.8				27.5																			
22	29.4				28.3			25.5																
24	30.4				28.2			25.5																
26	30.2				27.7			25.2									20.2				17.8			
28	29.6	29.5			27.0			24.8									20.0				17.5			
30	28.0	28.2			25.5	25.2		24.4									19.6				17.2		15.4	
32	26.4	26.8			24.2	23.9		23.8									19.3				16.8		14.8	
34	24.9	25.5			22.8	22.8		22.6	22.4								18.9				16.5		14.5	
36		24.3	22.4		21.5	21.7		21.5	21.3								18.5				16.2		14.2	
38		23.1	21.1		20.6	19.4		20.4									18.2	17.6			15.8	15.3	13.8	
40		21.9	19.9		19.7	18.3		19.5	17.4								18.0				16.8	16.0	12.7	
42			18.8			17.3		18.6	16.5								17.2				16.1	14.0	12.1	
44			17.8			16.4			15.6								16.4	14.2			15.4	13.4	11.5	
46						15.6			14.8								14.2				13.5	12.7	11.0	
48									14.1												12.8	12.3	10.5	
50																					11.6	11.0	10.0	
52																					12.1	11.0	9.8	
54																						10.5	9.5	8.5
56																						10.5	9.5	8.5
58																						10.5	9.5	8.5
60																						10.5	9.5	8.5
62																						10.5	9.5	8.5

64401

 35.2m-65.6m
 
 3.5m
 
 E
 
 82°/75°/68° 36m
 
 8.9m x 8.53m
 
 360°
 
 140t
 
Y-ガイ

メインブーム長さ ジブ長さ	35.2m+7m 36m			40.3m+7m 36m			45.3m+7m 36m			50.4m+7m 36m			55.5m+7m 36m			60.5m+7m 36m			65.6m+7m 36m				
	角度	82°	75°	68°	82°	75°	68°	82°	75°	68°	82°	75°	68°	82°	75°	68°	82°	75°	68°	82°	75°	68°	
作業半径(m)																							
20	22.2																						
22	23.1				22.5			17.1															
24	24.1				23.0			19.4															
26	24.8				23.2			21.0															
28	24.5				23.1			21.1															
30	24.1	23.6			22.8			20.9															
32	23.2	23.6			22.3	21.7		20.6															
34	22.2	23.0			21.2	20.7		20.3	19.9														
36	21.2	22.0			20.2	19.7		20.0	19.7														
38	20.3	21.0	20.5		19.2	18.9		19.7	19.3														
40	19.4	20.1	19.7		18.2	18.0	17.2	18.9	18.5														
42		19.3	18.7			17.2	16.6	18.0	17.7														
44		18.4	17.7			16.5	15.9	17.0	15.2														
46		17.5	16.8			15.8	15.3	16.3	14.4														
48			16.0				14.6	15.7	13.7														
50			15.2				13.9	13.0	12.3														
52							13.2		12.4														
54									11.8														
56																							
58																							
60																							
62																							

64501

起伏式ジブ(ガイ、エクセンダー仕様) 定格総荷重表 TYVEN

LTM 1400NX



メインブーム長さ ジブ長さ	35.2m+7m 42m			40.3m+7m 42m			45.3m+7m 42m			50.4m+7m 42m			55.5m+7m 42m			60.5m+7m 42m			65.6m+7m 42m			
	82°	75°	68°	82°	75°	68°	82°	75°	68°	82°	75°	68°	82°	75°	68°	82°	75°	68°	82°	75°	68°	
22	20.0			18.0																		
24	20.4			18.5			16.2															
26	20.5			18.9			17.0															
28	20.3			19.0			17.3															
30	19.8			19.0			17.3															
32	19.2	19.2		18.7			17.3														10.6	
34	18.5	19.2		18.4	18.3		17.1														10.5	
36	17.6	18.5		17.9	18.0		16.9	16.5													10.3	
38	16.7	17.7		17.0	17.2		16.6	16.4													10.1	
40	16.0	16.9		16.3	16.4		16.4	16.2													9.9	
42	15.2	16.1	15.5	15.5	15.7		15.8	16.0													9.7	
44	14.5	15.4	14.9	14.8	15.0	14.0	15.1	15.4													9.5	9.0
46	13.9	14.8	14.3	14.2	14.3	13.5	14.4	14.8	13.9												9.3	8.9
48		14.1	13.8		13.7	13.0	13.9	14.1	13.4	14.0											9.1	8.6
50		13.4	13.2		13.1	12.5		13.6	12.8												8.9	8.2
52		12.6	12.7		12.5	12.0		13.1	12.2												8.9	8.2
54			12.2			11.6		12.6	11.6												8.9	8.2
56			11.7			11.1		11.1	11.1												8.9	8.2
58						10.7			10.6												8.9	8.2
60									10.1												8.9	8.2
62																					8.9	8.2
64																					8.9	8.2
66																					8.9	8.2
68																					8.9	8.2

64601

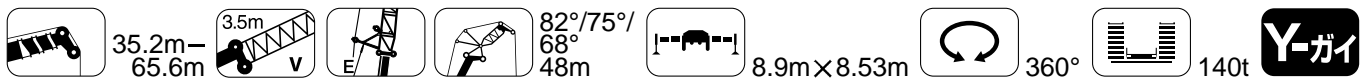

メインブーム長さ ジブ長さ	35.2m+7m 48m			40.3m+7m 48m			45.3m+7m 48m			50.4m+7m 48m			55.5m+7m 48m			60.5m+7m 48m			65.6m+7m 48m			
	82°	75°	68°	82°	75°	68°	82°	75°	68°	82°	75°	68°	82°	75°	68°	82°	75°	68°	82°	75°	68°	
24	16.1			14.3																		
26	16.5			14.8			13.7															
28	16.6			15.3			14.1															
30	16.6			15.5			14.3															
32	16.4			15.6			14.3															
34	16.2	15.6		15.7			14.3															
36	16.0	15.6		15.6	15.0		14.2															
38	15.9	15.5		15.5	15.0		14.2	13.9														
40	15.7	15.5		15.4	15.0		14.1	13.8														
42	15.6	15.4		15.3	14.9		13.9	13.7														
44	15.1	14.7	13.9	15.0	14.3		13.7	13.5														
46	14.4	14.1	13.4	14.3	13.7		13.6	13.4														
48	13.7	13.5	12.9	13.7	13.1	12.1	13.4	13.0														
50	13.0	13.0	12.5	13.0	12.5	11.7	13.1	12.4	11.5	11.9	11.7											
52	12.3	12.4	12.0	12.4	12.0	11.2	12.5	11.9	11.1	11.8	11.5	10.5										
54		11.9	11.5		11.5	10.8	11.8	11.5	10.7	11.6	11.1	10.0	10.1	9.8								
56		11.3	11.1		11.0	10.4		11.0	10.3													
58		10.6			10.5	10.0		10.5	9.9													
60			10.3			9.7		10.1	9.5													
62			9.9			9.3			9.2													
64						8.9			8.8													
66									8.5													
68																						
70																						
72																						
74																						

64701

起伏式ジブ (ガイ、エクセンダー仕様) 定格総荷重表 TYVEN

LTM 1400NX

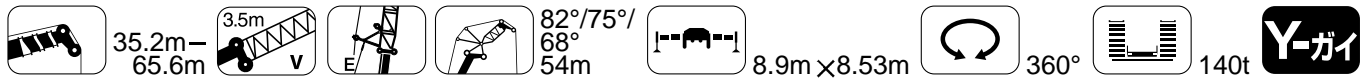

メインブーム長さ ジブ長さ 作業半径(m)	35.2m+7m 54m			40.3m+7m 54m			45.3m+7m 54m			50.4m+7m 54m			55.5m+7m 54m			60.5m+7m 54m			65.6m+7m 54m			
	82°	75°	68°	82°	75°	68°	82°	75°	68°	82°	75°	68°	82°	75°	68°	82°	75°	68°	82°	75°	68°	
26	12.8			12.2																		
28	13.0			12.4			10.7															
30	13.3			12.5			11.1						10.0			7.1						
32	13.4			12.6			11.4						10.3			8.6			7.7			
34	13.3			12.6			11.5						10.4			8.9			7.9			7.0
36	13.2	12.7		12.6			11.6						10.5			9.1			8.0			7.0
38	13.1	12.6		12.6	12.2		11.5						10.5			9.1			8.0			7.0
40	13.0	12.6		12.5	12.2		11.5	11.4					10.4			9.1			8.0			7.0
42	12.8	12.5		12.5	12.2		11.4	11.3					10.4	10.1		9.1			7.9			6.9
44	12.7	12.5		12.4	12.1		11.4	11.2					10.3	10.0		9.0			7.9			6.9
46	12.6	12.5		12.3	11.7		11.3	11.1					10.2	9.9		8.9	8.5		7.8	7.3		6.7
48	12.6	12.4	11.5	12.0	11.3		11.2	11.0					10.1	9.8		8.8	8.4		7.7	7.2		6.6
50	12.5	12.2	11.5	11.5	10.8		11.1	10.9					9.9	9.7		8.7	8.3		7.5	7.1		6.5
52	12.0	11.7	11.1	11.0	10.4		9.4	11.0	10.8	10.1			9.8	9.6		8.5	8.2		7.4	7.0		6.3
54	11.5	11.2	10.7	10.5	9.9	9.1	10.9	10.9	10.7	9.7	9.7		9.5			8.4	8.1		7.3	6.9		6.2
56	10.9	10.8	10.3	10.0	9.5	8.8	10.8	10.3	9.4	9.6	9.4		8.5	8.3		8.0			7.1	6.8		6.1
58	10.4	10.4	9.9	9.5	9.1	8.4	10.4	9.9	9.0	9.5	9.3		8.2	8.2		7.9	7.3		7.0	6.7		5.9
60		9.9	9.6		8.8	8.1		9.9	9.5	8.7	9.4		8.9	8.0		8.1	7.8	7.1	6.9	6.6	1.8	5.8
62		9.5	9.2		8.4	7.8		9.1	8.4				8.6	7.7		7.7	7.3	7.0	6.8	6.5		5.7
64		8.8	8.9		8.0	7.5		8.8	8.1				8.2	7.4		7.7	7.4	7.0	6.8	6.4	2.0	5.1
66			8.5			7.2		8.4	7.8				7.9	7.1		7.5	7.2	6.8	6.5	6.3	2.0	4.9
68			8.2			6.9			7.6				7.6	6.8		7.2	6.9	6.5	6.2	6.0	2.0	4.7
70						6.6								6.6				5.9	5.4	5.4	2.0	4.5
72														6.3				5.6		5.6	2.0	4.3
74														6.0				5.3		5.3	1.9	4.2
76																		5.0			1.7	4.1
78																					1.5	4.0
80																						1.8

64801

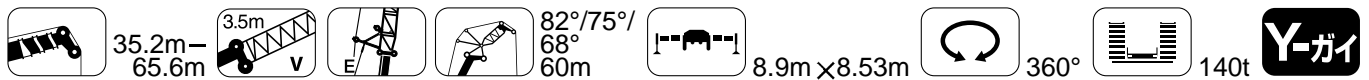

メインブーム長さ ジブ長さ 作業半径(m)	35.2m+7m 60m			40.3m+7m 60m			45.3m+7m 60m			50.4m+7m 60m			55.5m+7m 60m			60.5m+7m 60m			65.6m+7m 60m			
	82°	75°	68°	82°	75°	68°	82°	75°	68°	82°	75°	68°	82°	75°	68°	82°	75°	68°	82°	75°	68°	
28	9.9			9.3																		
30	10.1			9.5			8.6					7.3										
32	10.2			9.7			8.8					7.8				6.3						
34	10.4			9.8			8.9					7.9				6.6			4.6			
36	10.5			9.9			9.0					8.0				6.8			5.6			
38	10.6			9.9			9.0					8.1				6.9			5.8			3.1
40	10.5	10.1		9.9			9.0					8.1				6.9			6.0			5.2
42	10.4	10.1		9.9	9.8		9.0	9.1				8.1				6.9			6.1			5.2
44	10.3	10.0		9.9	9.8		9.0	9.0				8.1				6.9			6.0			5.2
46	10.2	10.0		9.9	9.7		8.9	9.0				8.1	7.9			6.9	6.7		6.0			5.2
48	10.1	9.9		9.8	9.7		8.9	8.9				8.0	7.9			6.8	6.6		6.0			5.1
50	10.0	9.9	9.2	9.8	9.6		8.8	8.8				8.0	7.8			6.8	6.6		5.9	5.6		5.0
52	9.9	9.8	9.2	9.8	9.6		8.8	8.7				7.9	7.7			6.7	6.5		5.9	5.5		5.0
54	9.9	9.7	9.2	9.7	9.3	8.3	8.7	8.6				7.8	7.6			6.6	6.4		5.8	5.4		4.9
56	9.8	9.7	9.2	9.6	8.9	8.0	8.7	8.6	8.1			7.7	7.5			6.6	6.3		5.7	5.3		4.8
58	9.8	9.7	9.1	9.2	8.6	7.7	8.6	8.5	7.8			7.6	7.5	7.0		6.5	6.3		5.6	5.3		4.7
60	9.6	9.3	8.8	8.8	8.2	7.4	8.4	8.4	7.5	7.6	7.4	6.9	6.4	6.2	1.8	6.4	6.2		5.5	5.2		4.6
62	9.2	9.0	8.5	8.4	7.9	7.2	8.2	8.1	7.2	7.5	7.3	6.6	6.3	6.1	2.0	6.3	6.1		5.4	5.1		4.5
64		8.6	8.2	8.0	7.6	6.9	7.9	7.7	7.0	7.3	7.2	6.4	6.3	6.1	2.2	6.0	5.8		5.2	5.0		4.3
66		8.3	7.9		7.3	6.6	7.6	7.4	6.7	7.1	7.0	6.1	6.1	5.9	2.2	5.9	5.7		5.2	4.9		4.3
68		7.9	7.6		6.9	6.4		7.1	6.5		6.7	5.9			5.9	5.7	5.3		5.2	4.9		4.2
70		7.4	7.4		6.6	6.1		6.8	6.2		6.5	5.7			5.8	5.6	5.2		4.8	4.5		3.8
72			7.1		5.9	5.4		6.5	6.0		6.2	5.4			5.8	5.6	5.2		4.7	4.4		3.7
74			6.8			5.6			5.7		5.9	5.2			5.1	5.1	4.7		4.7	4.3		3.6
76						5.4			5.5			5.0				5.1	4.7		4.4	4.1		3.5
78									5.3			4.8					4.4		4.4	4.0		3.3
80												4.6							4.1	3.7		3.1
82																			4.0	3.6		3.0
84																			3.9	3.5		2.9

64901

起伏式ジブ(ガイ、エクセンダー仕様) 定格総荷重表 TYVEN

LTM 1400NX



メインブーム長さ ジブ長さ 作業半径(m)	35.2m+7m 66m			40.3m+7m 66m			45.3m+7m 66m			50.4m+7m 66m			55.5m+7m 66m			60.5m+7m 66m		
	82°	75°	68°	82°	75°	68°	82°	75°	68°	82°	75°	68°	82°	75°	68°	82°	75°	
28	8.3																	
30	8.3			7.2			6.8											
32	8.4			7.4			6.9											
34	8.5			7.5			7.0						3.9				3.0	
36	8.5			7.7			7.1						4.4				4.0	
38	8.5			7.7			7.2						5.0				4.1	
40	8.5			7.8			7.2						5.1				4.2	
42	8.5	8.0		7.9			7.1						5.2				4.4	
44	8.4	8.1		7.9	7.7		7.1	7.2					5.3				4.4	
46	8.3	8.1		7.8	7.8		7.1	7.2					5.3				4.4	
48	8.2	8.1		7.8	7.8		7.0	7.2					5.3				4.4	
50	8.2	8.0		7.8	7.8		7.0	7.1					5.3	5.2			4.4	
52	8.1	8.0		7.8	7.8		7.0	7.1					5.2	5.1			4.3	3.7
54	8.0	7.9	7.3	7.8	7.7		6.9	7.0					5.2	5.1			4.3	3.8
56	8.0	7.8	7.4	7.7	7.7	6.9	6.9	6.9					5.2	5.0			4.3	3.8
58	7.9	7.8	7.4	7.6	7.7	7.0	6.8	6.9	6.4	6.0	6.0		5.1	5.0			4.2	3.8
60	7.9	7.8	7.2	7.5	7.6	6.7	6.6	6.8	6.4	6.0	5.9		5.1	4.9			4.2	3.8
62	7.8	7.5	6.9	7.4	7.4	6.5	6.5	6.7	6.1	5.9	5.8	4.8	5.0	4.8			4.1	3.7
64	7.6	7.2	6.7	7.3	7.1	6.3	6.4	6.7	5.9	5.9	5.8	4.9	5.0	4.8			4.0	3.6
66	7.2	6.9	6.4	7.2	6.8	6.0	6.2	6.5	5.7	5.7	5.7	4.9	4.9	4.7	1.2		4.0	3.6
68	6.8	6.6	6.2	7.0	6.5	5.8	6.0	6.2	5.4	5.6	5.7	4.9	4.8	4.6	1.4		3.9	3.4
70	6.4	6.3	5.9	6.6	6.2	5.6	5.8	5.9	5.2	5.3	5.6	4.8	4.6	4.6	1.5		3.9	3.2
72		6.0	5.7		5.9	5.3	5.6	5.7	5.0	5.1	5.4	4.6	4.4	4.5	1.5		3.6	3.0
74		5.7	5.5		5.7	5.1		5.4	4.8		5.2	4.4	4.5	4.6	1.6		3.4	2.7
76		5.2	5.2		5.4	4.9		5.2	4.6		4.9	4.2	4.4	4.4	1.6			2.5
78			5.0			4.7		4.9	4.4		4.7	4.0	4.4	4.4	1.6			2.1
80			4.7			4.5		4.2	4.2		4.4	3.8	4.1	4.1	1.5			1.8
82						4.3		4.0	4.0			3.6			1.3			1.3
84								3.7				3.2						
86												2.6						

65001

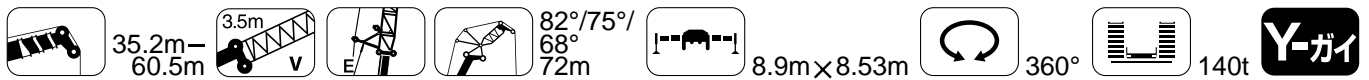

メインブーム長さ ジブ長さ 作業半径(m)	35.2m+7m 72m			40.3m+7m 72m			45.3m+7m 72m			50.4m+7m 72m			55.5m+7m 72m			60.5m+7m 72m		
	82°	75°	68°	82°	75°	68°	82°	75°	68°	82°	75°	68°	82°	75°	68°	82°	75°	
30	6.5																	
32	6.5			5.6			5.1											
34	6.6			5.7			5.3											
36	6.6			5.8			5.4						4.3					
38	6.6			5.9			5.5						4.5					
40	6.7			6.0			5.5						4.7					
42	6.6			6.0			5.6						4.8					
44	6.6			6.1			5.6						4.9					
46	6.5	6.0		6.1	5.8		5.6						4.9					
48	6.5	6.2		6.1	5.9		5.5	5.5					4.9					
50	6.4	6.2		6.1	6.0		5.5	5.6					4.9	5.0				
52	6.4	6.2		6.1	6.0		5.5	5.6					4.8	4.9				
54	6.3	6.2		6.1	6.0		5.4	5.6					4.8	4.9				
56	6.3	6.2	5.3	6.0	6.0		5.4	5.5					4.8	4.8				
58	6.2	6.1	5.4	6.0	6.0		5.3	5.5					4.8	4.8				
60	6.1	6.1	5.5	5.9	6.0	5.1	5.3	5.4					4.7	4.7				
62	6.1	6.1	5.6	5.8	5.9	5.2	5.2	5.4	4.8				4.7	4.6				
64	6.0	6.0	5.7	5.7	5.9	5.3	5.1	5.3	4.9				4.6	4.6				
66	6.0	6.0	5.7	5.7	5.9	5.4	5.0	5.3	4.9				4.5	4.5	3.6			
68	5.9	6.0	5.6	5.6	5.8	5.2	4.8	5.2	4.9				4.4	4.5	3.8			
70	5.8	5.9	5.4	5.5	5.8	5.0	4.7	5.2	4.6	4.3			4.4	4.4	3.8			
72	5.7	5.6	5.2	5.4	5.5	4.8	4.6	5.2	4.5	4.2			4.4	4.4	3.8			
74	5.6	5.4	5.0	5.3	5.3	4.6	4.4	5.0	4.3	4.0			4.4	4.4	3.7			
76	5.3	5.1	4.8	5.2	5.0	4.4	4.3	4.8	4.1	3.9			4.3	4.3	3.6			
78		4.9	4.6		4.8	4.2	4.1	4.6	3.9	3.7			4.3	4.3	3.5			
80		4.6	4.4		4.6	4.1	4.1	4.3	3.7	3.7			4.1	4.1	3.3			
82		4.2	4.2		4.3	3.9	3.9	4.1	3.6	3.6			3.9	3.9	3.2			
84			4.0			3.7	3.7	3.8	3.4	3.4			3.7	3.7	3.1			
86			3.7			3.5	3.5	3.3	3.3	3.3			3.4	3.4	2.9			
88						3.3	3.3	3.1	2.9	2.9					2.8			
90															2.5			
92															2.0			

65101

起伏式ジブ (ガイ、エクセンダー仕様) 定格総荷重表 TYVEN

LTM 1400NX

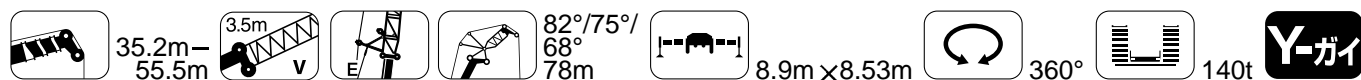

メインブーム長さ ジブ長さ 角度 作業半径(m)	35.2m+7m 78m			40.3m+7m 78m			45.3m+7m 78m			50.4m+7m 78m			55.5m+7m 78m	
	82°	75°	68°	82°	75°	68°	82°	75°	68°	82°	75°	68°	82°	75°
32	4.8													
34	4.9			4.5			3.6							
36	4.9			4.6			3.8			2.8				
38	5.0			4.6			3.9			3.0				1.3
40	4.9			4.6			3.9			3.2				1.6
42	4.9			4.6			4.0			3.3				1.8
44	4.8			4.6			4.1			3.4				2.1
46	4.8	4.5		4.6			4.1			3.4				2.4
48	4.8	4.6		4.6	4.3		4.1			3.5				2.6
50	4.7	4.6		4.5	4.4		4.1	4.0		3.5				2.6
52	4.7	4.7		4.5	4.5		4.0	4.1		3.5	3.6			2.7
54	4.7	4.7		4.4	4.5		4.0	4.2		3.5	3.6			2.7
56	4.6	4.8		4.4	4.6		3.9	4.2		3.5	3.6			2.8
58	4.6	4.8		4.4	4.6		3.9	4.2		3.5	3.5			2.7
60	4.5	4.8	3.9	4.3	4.6		3.8	4.1		3.4	3.5			2.7
62	4.5	4.7	4.0	4.2	4.6		3.7	4.1		3.4	3.4			2.7
64	4.4	4.7	4.1	4.2	4.6		3.7	4.0	3.4	3.3	3.4			2.7
66	4.4	4.6	4.2	4.1	4.5		3.6	4.0	3.5	3.2	3.3			2.6
68	4.3	4.6	4.2	4.0	4.5		3.5	4.0	3.6	3.2	3.3	2.5		2.6
70	4.3	4.5	4.3	4.0	4.4		3.4	3.9	3.6	3.1	3.3	2.6		2.5
72	4.2	4.5	4.3	3.9	4.3		3.3	3.9	3.6	3.0	3.2	2.7		2.5
74	4.1	4.5	4.3	3.8	4.1	3.4	3.2	3.9	3.6	2.9	3.2	2.8		2.5
76	4.1	4.4	4.2	3.8	3.9	3.3	3.1	3.8	3.5	2.7	3.2	2.8		2.4
78	4.0	4.4	4.0	3.7	3.7	3.1	3.0	3.8	3.4	2.6	3.1	2.8		2.4
80	4.0	4.2	3.8	3.6	3.5	3.0	2.8	3.8	3.2	2.5	3.1	2.7		2.3
82	3.9	4.0	3.7	3.5	3.4	2.9	2.7	3.7	3.1	2.3	3.1	2.7		2.3
84		3.8	3.5		3.1	2.1		3.5	2.9	2.2	3.0	2.6		2.3
86		3.5	3.3		2.9	1.4		3.3	2.8		3.0	2.5		2.3
88		3.2	3.2		2.7			3.2	2.7		3.0	2.3		2.2
90			3.0					2.9	2.6		2.8	2.2		2.2
92			2.9						2.4		2.6	2.1		2.2
94									2.3			2.0		
96									2.1			1.7		

65201

主部材寸法

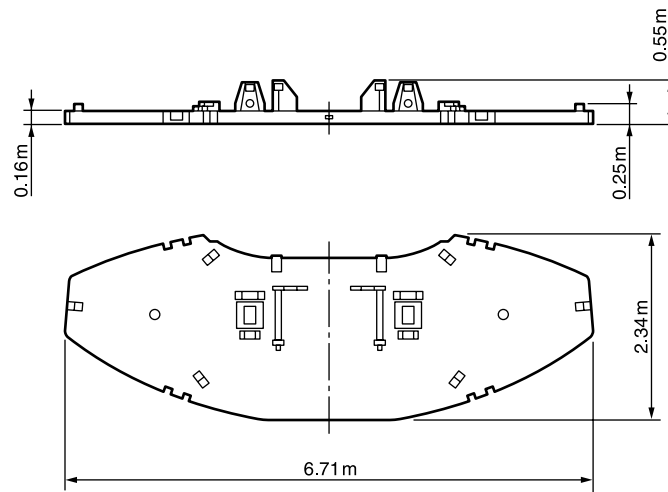

カウンタウエイト 15.0t

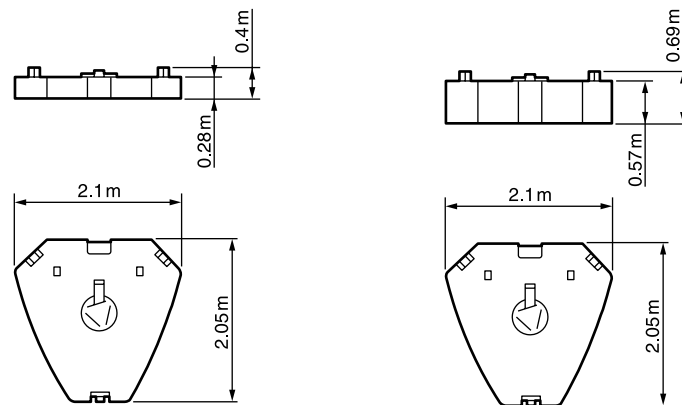

カウンタウエイト 5.0t

カウンタウエイト 10.0t

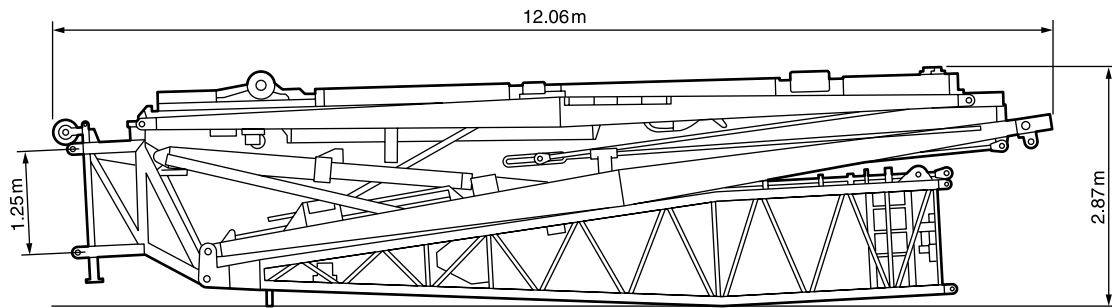

起伏ジブ基部 8.0t 幅 2.01m

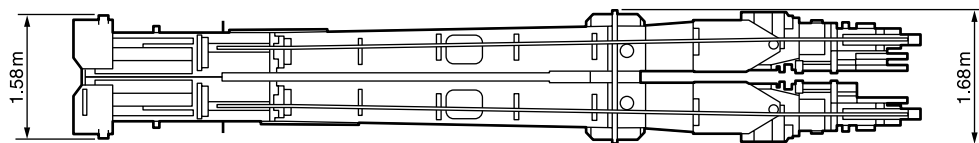
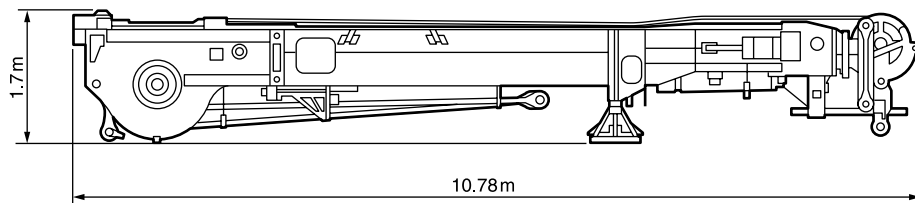

TY-ガイ(輸送用装置付) 14.0t

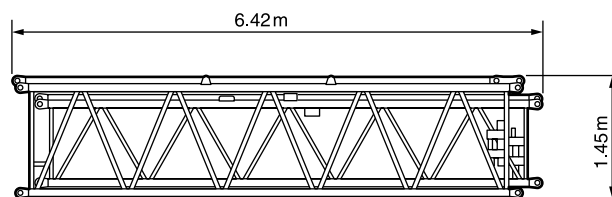

中間ジブ 6m 1.5t 幅 1.73m

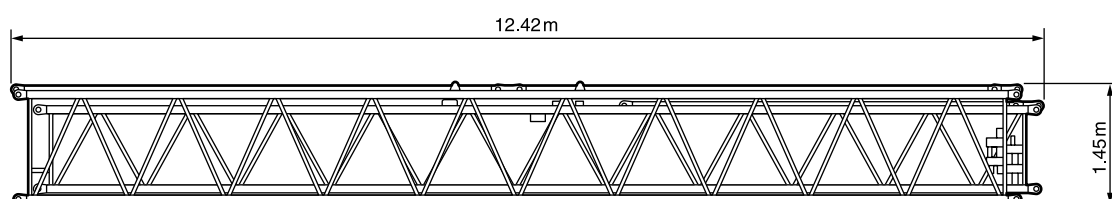

中間ジブ 12m 2.7t 幅 1.73m

主寸法

LTM 1400NX

外観寸法

単位：mm

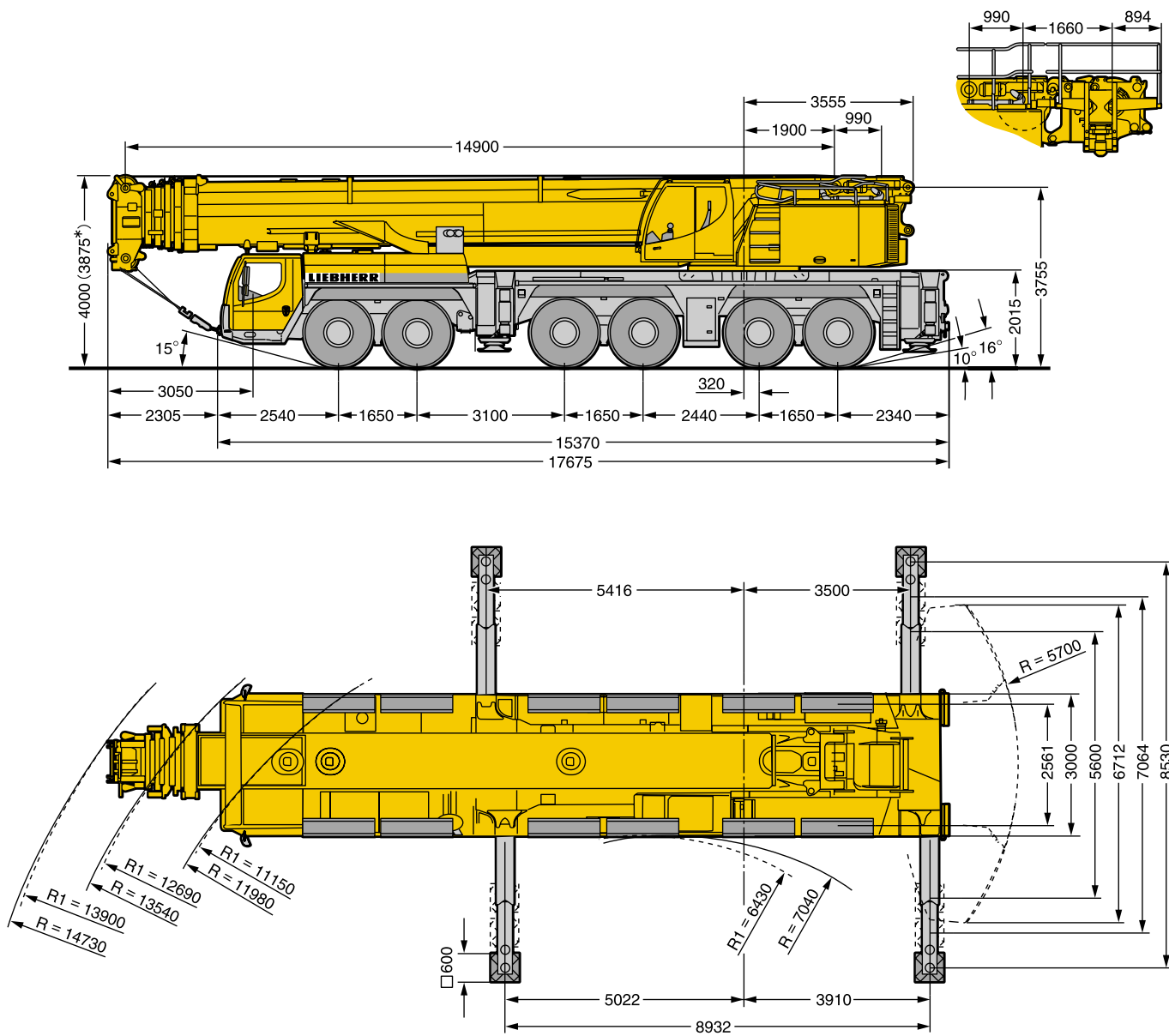

*サスペンションを125mm下げた状態
R1 = 全輪ステアリング時

リープヘル・ジャパン株式会社

〒230-0053 横浜市鶴見区大黒町5番39号

TEL 045-505-8687 (営業)

045-505-8689 (サービス)

FAX 045-505-8683

なお、本仕様は予告なく変更することがあります。

TD 180.00.DEFISR01.2009
2010.2.2000