

▶主要諸元 (型式：7200)

項目	仕様	クローラクレーン		ラフティングタワー
		ヘビイ	ライト	
最大つり上げ能力	t × m	200 × 4.5	150 × 6.0	25 × 14.0
ブーム (タワー) 長さ	m	15.2 ~ 67.1	18.3 ~ 67.1	36.6 ~ 58.0
		70.1 ~ 88.4 (ロング)		
タワージブ長さ	m	-		27.4 ~ 48.8
最大タワー + タワージブ長さ	m	-		58.0 + 48.8
ロープ速度	主巻	m/min	*110 ~ 3	
	補巻	m/min	*110 ~ 3	
	タワージブ起伏	m/min	-	
	ブーム (タワー) 起伏	m/min	*(26 ~ 1) × 2	
旋回速度	min ⁻¹ {rpm}	2.1 {2.1}		
走行速度	km/h	*1.1/0.7		
作業時質量 (基本姿勢)	t	197 ¹ /162 ²	162	175
接地圧 (基本姿勢)	kPa {kgf/cm ² }	110 {1.12} ¹ /90 {0.92} ²	90 {0.92}	97 {0.99}
登坂能力 (tan)	% (度)	30 (16.7)		-
定格ラインプル	kN {tf}	1本掛132 {13.5} / 2本掛以上123 {12.5}		-
エンジン	名称	三菱6D24-TCE1		
	定格出力	kW/min ⁻¹ {PS/rpm}		
ワイヤロープ	主巻	mm	28	
	補巻	mm	28	-
	タワージブ起伏	mm	-	22 (8本掛)
	ブーム (タワー) 起伏	mm	22 (16本掛)	
	ブーム (タワー) ガイライン	mm	34 (2 × 2本式)	
	タワージブガイライン	mm	-	

各ロープ速度はドラム1層目での値です。

*印の速度は軽負荷の時の値であり、負荷により速度の変動があります。

単位は国際単位系のSI単位で、{ }内は従来表示です。

1 102.2tウエイト

2 66.6tウエイト

▶仕様とアタッチメント (クローラクレーン/ラフティングタワー)

アタッチメント	仕様	クローラクレーン		ラフティングタワー
		ヘビイ	ライト	
カウンタウエイト		102.2t ^{*1} /66.6t	66.6t	66.6t
7.6m下部ブーム (共用)				
3.0m中間ブーム (共用)				
6.1m中間ブーム (共用)				
9.1m中間ブーム (共用)				
9.1m中間ブーム (ガイドシーブ付) ^{*2}		転用可能		
7.6mヘビイ上部ブーム (200t吊り)			-	-
5.2mライト上部ブーム (150t吊り)				-
5.4m中間テーパーブーム ^{*3}		/		-
8.3m上部タワージブ ^{*4}				
タワーキャップ		-	-	
10.0m下部タワージブ		-	-	
3.0m中継ジブ ^{*5}				
3.0m中間タワージブ ^{*6}				
6.1m中間タワージブ ^{*6}				
9.1m中間タワージブ ^{*6}				
200tフック (8枚シーブ)			-	-
150tフック (100t兼用、6枚シーブ) ^{*7}				-
100tフック (4枚シーブ)				-
65tフック (3枚シーブ)				-
35tフック (1枚シーブ)				
13.5tボールフック				
補助シーブ				-
主巻ワイヤロープ (28)		370m	370m	370m
補巻ワイヤロープ	補巻 (28)	210m	210m	-
	タワージブ起伏 (22)	-	-	185m
ブーム (タワー) 起伏ワイヤロープ (22)		280m	280m	315m

は基本仕様、は選択可能なアタッチメントを示します。

はロング仕様を構成する場合に必要なアタッチメントを示します。

*1 カーボディウエイト (20t) を含みます。

*2 クレーンの中間ブームに転用できます。詳細は取扱説明書をご覧ください。

*3 ライト上部ブームまたは3.0m中継ジブとセットで使用します。

*4 ロング仕様では上部ブームとして使用します。

*5 ロング仕様では5.4m中間テーパーブームと、ラフティングタワーでは下部タワージブとセットで使用します。

*6 ブーム長さ76.2m以上のロング仕様で中間ブームとして使用します。

*7 シーブの組替えで150tフックと100tフックの兼用ができます。

▶フック巻上限界 (単位：m)

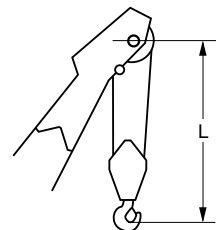

使用フック	L
200tフック	5.1
150tフック	6.0
100tフック	4.9
65tフック	4.8
35tフック	4.6
13.5tフック	4.2

巻掛本数はフックによって異なります。

全体図 (単位: mm)

縮尺: 約 1/150

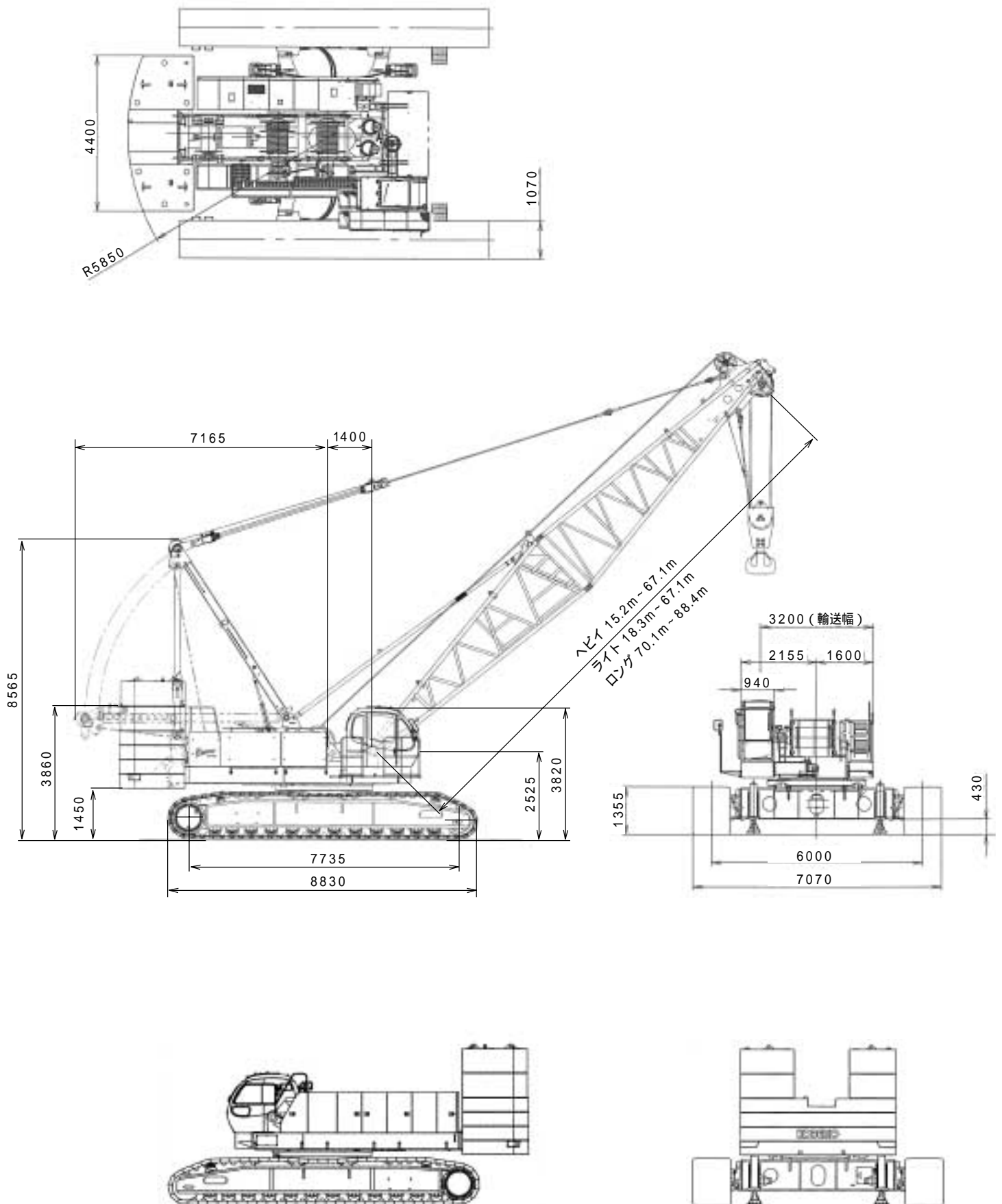

▶ ブーム構成

- は、これより短いブームの組立可能な構成を示します。
- 使用するガイラインの径は 34mmです。
- 仕様により必要となる中間ブーム ([3] および [6]) の数が異なります。

● 上部ブームの種類

仕様	記号	長さ	備考
ヘビイ		7.6m	
ライト		5.2m	[T] とセットで使用
ロング		8.3m	タワー上部ジブと兼用

● 中間ブームの種類

記号	長さ	備考
[3]	3.0m	
[6]	6.1m	
[9]	9.1m	
	9.1m	中間タワーブーム、ガイドシーブ付
[T]	5.4m	テーパー中間ブーム
[C]	3.0m	中継ジブ：ロング仕様で [T] とセットで使用
[3]	3.0m	中間タワージブと兼用
[6]	6.1m	中間タワージブと兼用
[9]	9.1m	中間タワージブと兼用

ブーム長さm	上段：ヘビイ 下段：ライト	
15.2		ヘビイのみ
18.3		
21.3		
24.4		
27.4		
30.5		
33.5		
36.6		
39.6		
42.7		

ブーム 長さm	上段：ヘビイ 下段：ライト		
45.7			
48.8			
51.8			
54.9			
57.9			
61.0			
64.0			
67.1			

ブーム 長さm	ロング	
70.1		
73.2		
76.2		
79.2		
82.3		
85.3		
88.4		

6 を 3|3 にする場合は必ず下部ブーム側に構成して下さい。

▶作動範囲図

■ヘビイ

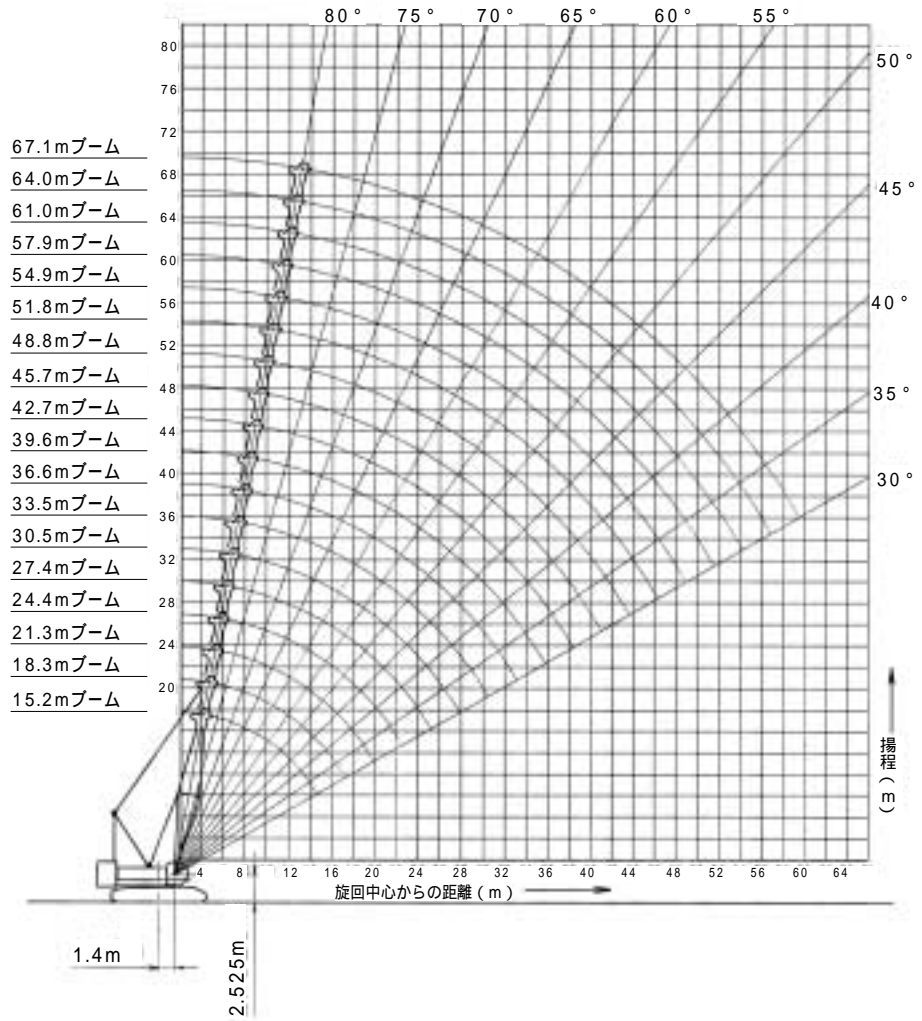

▶ライト

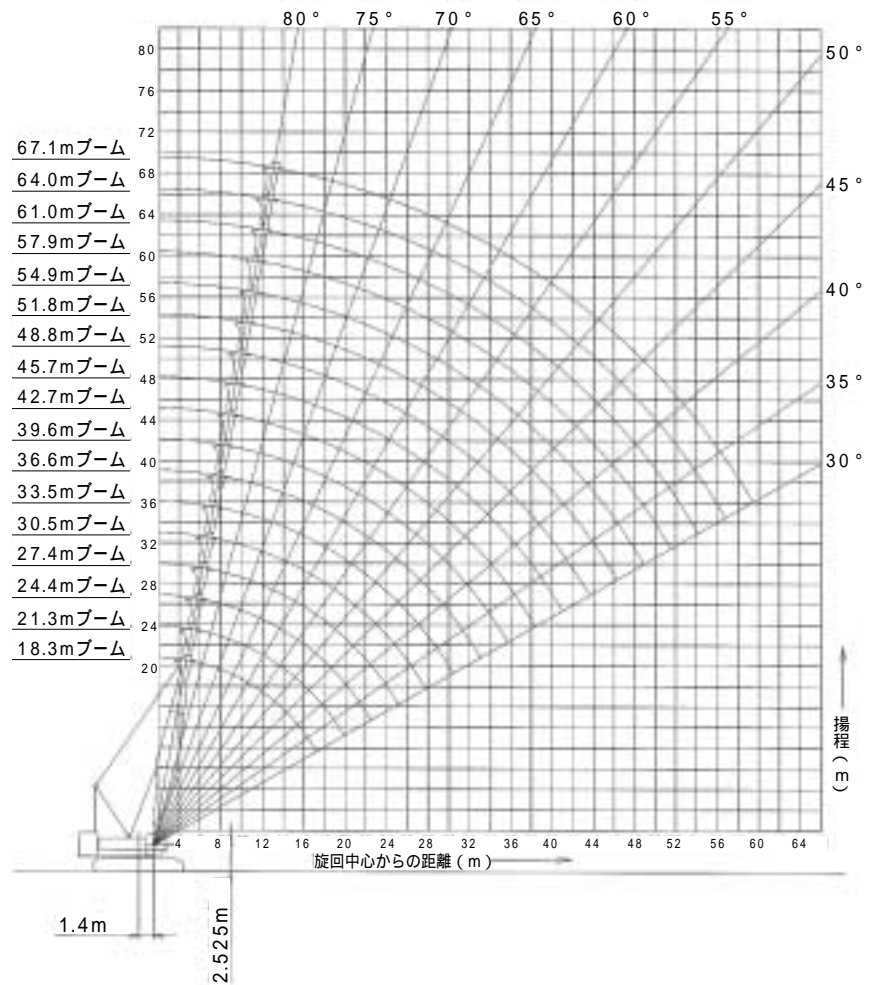

▶ ロング

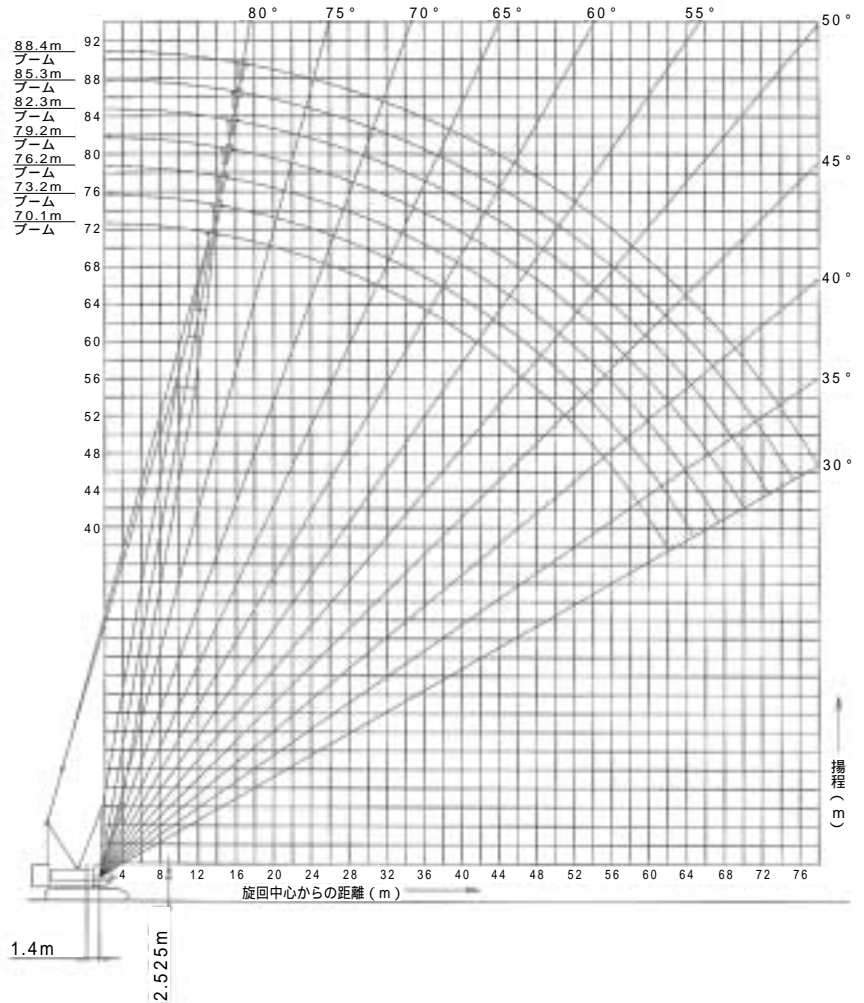

▶ 定格総荷重

- 定格総荷重とは、水平堅土上における転倒荷重の78%以内で、フックブロック、玉掛用ワイヤロープ等のつり具の質量を含んだ値です。
- 作業半径とはクレーン旋回中心よりつり上荷重の重心までの水平距離を意味します。
- 実際につり上げ得る荷重は定格総荷重から（フック+玉掛用ワイヤロープ等のつり具）の質量を差し引いた値になります。
- 定格総荷重をつる場合にも風の影響、地盤の状態、作業速度その他安全作業に有害な状況がある時はオペレータは荷重の軽減、作業速度を遅くするなど状況に応じた判断をする責任があります。
- 表中の空欄の個所では作業を行うことができません。
- クレーン作業中はガントリを最高位置に立ててください。

- すべてのブーム長さにおける中間ブームの構成は取扱説明書の指示を厳守してください。
- 補助シーブを取り付けたままで主フックを使用する場合の定格総荷重は、それぞれの仕様の主ブーム定格総荷重から一律0.9t差し引いた値となります。ただし、最小定格総荷重は2.4tとします。
- 補助シーブを装着できる主ブーム長さは下表のとおりです。

仕様	ブーム長さ(m)
ヘビイ	15.2~67.1
ライト	18.3~67.1
ロング	70.1~85.3

△ 操作ミスなどによるつり荷の落下を防ぐため、クレーン作業では自由降下（フリーフォール）作業は行わないでください。

● 巻上げロープ巻掛本数に対する最大巻上荷重とフックの質量

フックの呼び	最大巻上荷重 (t)												フックの質量
	1本掛	2本掛	3本掛	4本掛	5本掛	6本掛	7本掛	8本掛	10本掛	12本掛	14本掛	16本掛	
200t	13.5	25.0	37.5	50.0	62.5	75.0	87.5	100.0	125.0	150.0	175.0	200.0	2.8t
150t	13.5	25.0	37.5	50.0	62.5	75.0	87.5	100.0	125.0	150.0			2.3t
100t	13.5	25.0	37.5	50.0	62.5	75.0	87.5	100.0					1.8t
65t	13.5	25.0	37.5	50.0	62.5	65.0							1.2t
35t	13.5	25.0	35.0										0.9t
13.5t ボールフック	13.5												0.45t

付属するフックは、200t、150t、100t、65t、35t、13.5tとします。

▶ヘビイ主ブーム (102.2tウエイト)

(単位:t)

ブーム長さ 作業半径 m	15.2	18.3	21.3	24.4	27.4	30.5	33.5	36.6	39.6	42.7	ブーム長さ 作業半径 m
	200.0/4.5m										
5.0	196.7	186.5/5.0m	168.9/5.5m								5.0
6.0	166.1	165.8	164.6	149.1/6.0m	133.1/6.5m						6.0
7.0	143.6	143.3	143.0	141.6	130.0	119.1/7.1m	100.0/7.6m				7.0
8.0	126.4	126.1	125.8	124.8	122.0	114.3	100.0	97.5/8.1m	89.1/8.6m		8.0
9.0	107.9	110.4	110.0	108.5	106.3	104.4	100.0	94.2	87.9	81.4/9.2m	9.0
10.0	93.1	96.5	96.8	95.9	94.1	92.5	91.2	89.3	84.9	79.1	10.0
12.0	70.6	75.7	75.5	75.3	75.2	75.1	74.2	72.8	71.4	70.3	12.0
14.0	53.5	60.5	61.1	61.0	60.7	60.6	60.5	60.4	60.2	59.2	14.0
16.0	47.4/14.8m	48.3	51.1	51.0	50.7	50.6	50.5	50.3	50.1	50.0	16.0
18.0		40.5/17.4m	43.4	43.7	43.4	43.3	43.2	43.0	42.7	42.6	18.0
20.0			35.2	38.1	37.8	37.7	37.6	37.4	37.1	37.0	20.0
22.0			34.9/20.1m	32.7	33.5	33.3	33.2	32.9	32.7	32.6	22.0
24.0				30.6/22.7m	29.9	29.8	29.7	29.4	29.2	29.0	24.0
26.0					26.8/25.3m	26.9	26.7	26.5	26.2	26.1	26.0
28.0						23.8/28.0m	24.3	24.0	23.8	23.6	28.0
30.0							22.2	21.9	21.7	21.5	30.0
32.0							21.2/30.6m	20.2	19.9	19.7	32.0
34.0								18.9/33.3m	18.4	18.2	34.0
36.0									16.9/35.9m	16.8	36.0
38.0										15.6	38.0
40.0										15.1/38.5m	40.0

(単位:t)

ブーム長さ 作業半径 m	45.7	48.8	51.8	54.9	57.9	61.0	64.0	67.1	ブーム長さ 作業半径 m
9.0	74.6/9.7m								9.0
10.0	73.9	68.4/10.2m	62.8/10.8m	57.8/11.3m	53.4/11.8m				10.0
12.0	69.0	64.9	60.9	56.6	53.1	49.2/12.3m	44.9/12.9m	41.4/13.4m	12.0
14.0	58.1	57.2	56.3	53.5	50.1	46.9	43.4	40.6	14.0
16.0	49.8	49.3	48.4	47.7	46.9	44.3	41.0	38.3	16.0
18.0	42.4	42.3	42.1	41.8	41.0	40.3	38.6	36.1	18.0
20.0	36.8	36.7	36.5	36.4	36.2	35.7	35.1	34.0	20.0
22.0	32.4	32.2	32.0	31.9	31.7	31.5	31.4	30.7	22.0
24.0	28.8	28.6	28.5	28.3	28.1	27.9	27.8	27.6	24.0
26.0	25.8	25.7	25.5	25.4	25.1	25.0	24.9	24.6	26.0
28.0	23.4	23.2	23.0	22.9	22.7	22.5	22.4	22.1	28.0
30.0	21.3	21.1	20.9	20.8	20.5	20.3	20.2	20.0	30.0
32.0	19.5	19.3	19.1	19.0	18.7	18.5	18.4	18.2	32.0
34.0	17.9	17.7	17.5	17.4	17.1	16.9	16.8	16.6	34.0
36.0	16.6	16.4	16.2	16.0	15.8	15.6	15.4	15.2	36.0
38.0	15.4	15.2	14.9	14.8	14.5	14.3	14.2	14.0	38.0
40.0	14.3	14.1	13.9	13.7	13.5	13.2	13.1	12.9	40.0
42.0	13.5/41.2m	13.1	12.9	12.7	12.5	12.3	12.1	11.9	42.0
44.0		12.0/43.8m	12.1	11.9	11.6	11.4	11.3	11.0	44.0
46.0			11.0	11.1	10.8	10.6	10.5	10.2	46.0
48.0			10.7/46.5m	10.1	10.1	9.9	9.7	9.5	48.0
50.0				9.5/49.1m	9.2	9.2	9.1	8.8	50.0
52.0					8.3/51.7m	8.4	8.4	8.2	52.0
54.0						7.5	7.6	7.5	54.0
56.0						7.3/54.4m	6.7	6.8	56.0
58.0							6.3/57.0m	6.0	58.0
60.0								5.4/59.7m	60.0

表中の太線で囲まれた部分は、ブーム等の強度によって定められた値です。

▶ヘビイ補助シーブ(102.2tウエイト、主フックなし)

(単位:t)

ブーム長さ 作業半径 m	15.2	18.3	21.3	24.4	27.4	30.5	33.5	36.6	39.6	42.7	ブーム長さ 作業半径 m
	13.5/5.2m	13.5/5.7m									
6.0	13.5	13.5	13.5/6.2m	13.5/6.8m							6.0
7.0	13.5	13.5	13.5	13.5	13.5/7.3m	13.5/7.8m					7.0
8.0	13.5	13.5	13.5	13.5	13.5	13.5	13.5/8.4m	13.5/8.9m			8.0
9.0	13.5	13.5	13.5	13.5	13.5	13.5	13.5	13.5	13.5/9.4m	13.5/9.9m	9.0
10.0	13.5	13.5	13.5	13.5	13.5	13.5	13.5	13.5	13.5	13.5	10.0
12.0	13.5	13.5	13.5	13.5	13.5	13.5	13.5	13.5	13.5	13.5	12.0
14.0	13.5	13.5	13.5	13.5	13.5	13.5	13.5	13.5	13.5	13.5	14.0
16.0	13.5	13.5	13.5	13.5	13.5	13.5	13.5	13.5	13.5	13.5	16.0
18.0	13.5/16.1m	13.5	13.5	13.5	13.5	13.5	13.5	13.5	13.5	13.5	18.0
20.0		13.5/18.7m	13.5	13.5	13.5	13.5	13.5	13.5	13.5	13.5	20.0
22.0			13.5/21.4m	13.5	13.5	13.5	13.5	13.5	13.5	13.5	22.0
24.0				13.5/24.0m	13.5	13.5	13.5	13.5	13.5	13.5	24.0
26.0					13.5	13.5	13.5	13.5	13.5	13.5	26.0
28.0					13.5/26.7m	13.5	13.5	13.5	13.5	13.5	28.0
30.0						13.5/29.3m	13.5	13.5	13.5	13.5	30.0
32.0							13.5/31.9m	13.5	13.5	13.5	32.0
34.0								13.5	13.5	13.5	34.0
36.0								13.5/34.6m	13.5	13.5	36.0
38.0									13.5/37.2m	13.5	38.0
40.0										13.5/39.9m	40.0

(単位:t)

ブーム長さ 作業半径 m	45.7	48.8	51.8	54.9	57.9	61.0	64.0	67.1	ブーム長さ 作業半径 m
10.0	13.5/10.5m	13.5/11.0m	13.5/11.5m						10.0
12.0	13.5	13.5	13.5	13.5/12.1m	13.5/12.6m	13.5/13.1m	13.5/13.7m		12.0
14.0	13.5	13.5	13.5	13.5	13.5	13.5	13.5	13.5/14.2m	14.0
16.0	13.5	13.5	13.5	13.5	13.5	13.5	13.5	13.5	16.0
18.0	13.5	13.5	13.5	13.5	13.5	13.5	13.5	13.5	18.0
20.0	13.5	13.5	13.5	13.5	13.5	13.5	13.5	13.5	20.0
22.0	13.5	13.5	13.5	13.5	13.5	13.5	13.5	13.5	22.0
24.0	13.5	13.5	13.5	13.5	13.5	13.5	13.5	13.5	24.0
26.0	13.5	13.5	13.5	13.5	13.5	13.5	13.5	13.5	26.0
28.0	13.5	13.5	13.5	13.5	13.5	13.5	13.5	13.5	28.0
30.0	13.5	13.5	13.5	13.5	13.5	13.5	13.5	13.5	30.0
32.0	13.5	13.5	13.5	13.5	13.5	13.5	13.5	13.5	32.0
34.0	13.5	13.5	13.5	13.5	13.5	13.5	13.5	13.5	34.0
36.0	13.5	13.5	13.5	13.5	13.5	13.5	13.5	13.5	36.0
38.0	13.5	13.5	13.5	13.5	13.5	13.5	13.5	13.5	38.0
40.0	13.5	13.5	13.5	13.4	13.2	12.9	12.8	12.6	40.0
42.0	13.0	12.8	12.6	12.4	12.2	12.0	11.8	11.6	42.0
44.0	12.7/42.5m	11.7	11.8	11.6	11.3	11.1	11.0	10.7	44.0
46.0		11.2/45.1m	10.7	10.8	10.5	10.3	10.2	9.9	46.0
48.0			9.7/47.8m	9.8	9.8	9.6	9.4	9.2	48.0
50.0				8.8	8.9	8.9	8.8	8.5	50.0
52.0				8.6/50.4m	8.0	8.1	8.1	7.9	52.0
54.0					7.4/53.1m	7.2	7.3	7.2	54.0
56.0						6.4/55.7m	6.4	6.5	56.0
58.0							5.5	5.7	58.0
60.0							5.3/58.3m	5.1	60.0
62.0								4.8/61.0m	62.0

表中の太線で囲まれた部分は、ブーム等の強度によって定められた値です。

▶ロング主ブーム (102.2tウエイト)

(単位:t)

ブーム長さ 作業 半径 m	70.1	73.2	76.2	79.2	82.3	85.3	88.4	ブーム長さ 作業 半径 m
12.0	37.5/13.9m							12.0
14.0	37.5	37.5/14.4m	34.0/14.9m	32.2/15.4m				14.0
16.0	36.0	35.9	33.0	31.6	31.0/16.0m	25.0/16.5m	25.0/17.0m	16.0
18.0	34.4	34.3	31.2	29.9	29.2	25.0	24.9	18.0
20.0	33.0	32.9	29.7	28.4	27.7	25.0	23.4	20.0
22.0	31.7	31.6	28.4	27.0	26.4	25.0	22.1	22.0
24.0	28.8	28.7	27.2	25.8	25.2	23.7	20.9	24.0
26.0	25.8	25.7	25.6	24.8	24.1	22.6	19.9	26.0
28.0	23.4	23.3	23.2	23.1	23.0	21.6	19.0	28.0
30.0	21.2	21.1	21.0	20.9	20.8	20.7	18.2	30.0
32.0	19.4	19.3	19.2	19.1	19.0	18.9	17.5	32.0
34.0	17.8	17.7	17.6	17.5	17.4	17.3	16.9	34.0
36.0	16.4	16.3	16.2	16.1	16.0	15.9	15.8	36.0
38.0	15.2	15.1	15.0	14.9	14.8	14.7	14.6	38.0
40.0	14.1	14.0	13.9	13.8	13.7	13.6	13.5	40.0
42.0	13.1	13.0	12.9	12.8	12.7	12.6	12.5	42.0
44.0	12.2	12.1	12.0	11.9	11.8	11.7	11.6	44.0
46.0	11.4	11.3	11.2	11.1	11.0	10.9	10.8	46.0
48.0	10.7	10.6	10.5	10.4	10.3	10.2	10.1	48.0
50.0	10.1	9.9	9.8	9.7	9.6	9.5	9.4	50.0
52.0	9.5	9.3	9.2	9.1	9.0	8.9	8.8	52.0
54.0	8.9	8.8	8.7	8.6	8.5	8.4	8.3	54.0
56.0	8.4	8.3	8.2	8.1	8.0	7.9	7.8	56.0
58.0	7.9	7.8	7.7	7.6	7.5	7.4	7.3	58.0
60.0	7.4	7.3	7.2	7.1	7.0	6.9	6.8	60.0
62.0	6.7	6.7	6.7	6.6	6.5	6.4	6.3	62.0
64.0	6.6/62.3m	6.1	6.2	6.1	6.0	5.9	5.8	64.0
66.0		5.8/64.9m	5.6	5.6	5.5	5.4	5.3	66.0
68.0			5.2/67.5m	5.1	5.0	4.9	4.8	68.0
70.0				4.6/70.0m	4.5	4.4	4.3	70.0
72.0					4.0	3.9	3.8	72.0
74.0					3.8/72.8m	3.4	3.3	74.0
76.0						3.0/75.5m	2.8	76.0
78.0							2.4/78.0m	78.0

表中の太線で囲まれた部分は、ブーム等の強度によって定められた値です。

▶ロング補助シーブ

(102.2tウエイト、主フックなし)

(単位:t)

ブーム長さ 作業 半径 m	70.1	73.2	76.2	79.2	82.3	85.3	ブーム長さ 作業 半径 m
14.0	13.5/14.6m	13.5/15.1m	13.5/15.6m				14.0
16.0	13.5	13.5	13.5	13.5/16.1m	13.5/16.7m	13.5/17.2m	16.0
18.0	13.5	13.5	13.5	13.5	13.5	13.5	18.0
20.0	13.5	13.5	13.5	13.5	13.5	13.5	20.0
22.0	13.5	13.5	13.5	13.5	13.5	13.5	22.0
24.0	13.5	13.5	13.5	13.5	13.5	13.5	24.0
26.0	13.5	13.5	13.5	13.5	13.5	13.5	26.0
28.0	13.5	13.5	13.5	13.5	13.5	13.5	28.0
30.0	13.5	13.5	13.5	13.5	13.5	13.5	30.0
32.0	13.5	13.5	13.5	13.5	13.5	13.5	32.0
34.0	13.5	13.5	13.5	13.5	13.5	13.5	34.0
36.0	13.5	13.5	13.5	13.5	13.5	13.5	36.0
38.0	13.5	13.5	13.5	13.5	13.5	13.5	38.0
40.0	13.5	13.5	13.5	13.5	13.4	13.3	40.0
42.0	12.8	12.7	12.6	12.5	12.4	12.3	42.0
44.0	11.9	11.8	11.7	11.6	11.5	11.4	44.0
46.0	11.1	11.0	10.9	10.8	10.7	10.6	46.0
48.0	10.4	10.3	10.2	10.1	10.0	9.9	48.0
50.0	9.8	9.6	9.5	9.4	9.3	9.2	50.0
52.0	9.2	9.0	8.9	8.8	8.7	8.6	52.0
54.0	8.6	8.5	8.4	8.3	8.2	8.1	54.0
56.0	8.1	8.0	7.9	7.8	7.7	7.6	56.0
58.0	7.6	7.5	7.4	7.3	7.2	7.1	58.0
60.0	7.1	7.0	6.9	6.8	6.7	6.6	60.0
62.0	6.4	6.4	6.4	6.3	6.2	6.1	62.0
64.0	5.9/63.5m	5.8	5.9	5.8	5.7	5.6	64.0
66.0		5.3/66.0m	5.3	5.3	5.2	5.1	66.0
68.0			4.8	4.8	4.7	4.6	68.0
70.0			4.6/68.7m	4.3	4.2	4.1	70.0
72.0				4.0/71.4m	3.7	3.6	72.0
74.0					3.2/74.0m	3.1	74.0
76.0						2.6	76.0
78.0						2.4/76.7m	78.0

表中の太線で囲まれた部分は、ブーム等の強度によって定められた値です。

▶ヘビイ主ブーム (66.6tウエイト)

(単位:t)

ブーム長さ 作業半径 m	15.2	18.3	21.3	24.4	27.4	30.5	33.5	36.6	39.6	42.7	ブーム長さ 作業半径 m
4.5	200.0/4.5m										4.5
5.0	187.0	186.5/5.0m	168.9/5.5m								5.0
6.0	158.0	157.7	157.4	149.1/6.0m	133.1/6.5m						6.0
7.0	136.6	136.3	136.0	135.8	130.0	119.1/7.1m	100.0/7.6m				7.0
8.0	115.0	114.7	114.4	114.2	113.8	113.6	100.0	97.5/8.1m	89.1/8.6m		8.0
9.0	99.9	99.7	99.6	99.5	99.3	99.1	98.9	94.2	87.9	81.4/9.2m	9.0
10.0	85.0	84.8	84.6	84.4	84.3	84.2	84.1	84.0	83.9	79.1	10.0
12.0	65.3	65.0	64.8	64.7	64.4	64.3	64.2	64.1	63.9	63.8	12.0
14.0	52.8	52.5	52.2	52.1	51.8	51.7	51.6	51.5	51.3	51.2	14.0
16.0	47.4/14.8m	43.9	43.6	43.5	43.2	43.1	43.0	42.8	42.5	42.4	16.0
18.0		39.3/17.4m	37.3	37.2	36.8	36.7	36.5	36.4	36.2	36.1	18.0
20.0			32.6	32.4	32.0	31.9	31.8	31.5	31.3	31.2	20.0
22.0			32.5/20.1m	28.6	28.3	28.1	28.0	27.7	27.5	27.4	22.0
24.0				27.5/22.7m	25.2	25.0	24.9	24.6	24.4	24.3	24.0
26.0					23.5/25.3m	22.5	22.4	22.1	21.8	21.7	26.0
28.0						20.5/28.0m	20.3	20.0	19.7	19.6	28.0
30.0							18.5	18.2	17.9	17.8	30.0
32.0							18.0/30.6m	16.7	16.4	16.2	32.0
34.0								15.8/33.3m	15.1	14.9	34.0
36.0									14.0/35.9m	13.7	36.0
38.0										12.7	38.0
40.0										12.4/38.5m	40.0

(単位:t)

ブーム長さ 作業半径 m	45.7	48.8	51.8	54.9	57.9	61.0	64.0	67.1	ブーム長さ 作業半径 m
9.0	74.6/9.7m								9.0
10.0	73.9	68.4/10.2m	62.8/10.8m	57.8/11.3m	53.4/11.8m				10.0
12.0	63.6	63.5	60.9	56.6	53.1	49.2/12.3m	44.9/12.9m	41.4/13.4m	12.0
14.0	50.9	50.8	50.7	50.6	50.1	46.9	43.4	40.6	14.0
16.0	42.2	42.1	41.9	41.8	41.6	41.4	41.0	38.3	16.0
18.0	35.8	35.7	35.5	35.4	35.2	35.0	34.9	34.7	18.0
20.0	30.9	30.8	30.6	30.5	30.3	30.1	30.0	29.8	20.0
22.0	27.1	27.0	26.8	26.6	26.4	26.2	26.1	25.9	22.0
24.0	24.0	23.9	23.6	23.5	23.3	23.1	23.0	22.8	24.0
26.0	21.4	21.3	21.1	20.9	20.7	20.5	20.4	20.2	26.0
28.0	19.3	19.1	18.9	18.8	18.6	18.3	18.2	18.0	28.0
30.0	17.5	17.3	17.1	17.0	16.7	16.5	16.4	16.2	30.0
32.0	15.9	15.8	15.5	15.4	15.1	14.9	14.8	14.6	32.0
34.0	14.6	14.4	14.2	14.0	13.8	13.6	13.4	13.2	34.0
36.0	13.4	13.2	13.0	12.8	12.6	12.4	12.2	12.0	36.0
38.0	12.4	12.2	11.9	11.8	11.5	11.3	11.2	10.9	38.0
40.0	11.5	11.3	11.0	10.8	10.6	10.4	10.2	10.0	40.0
42.0	11.0/41.2m	10.4	10.2	10.0	9.7	9.5	9.4	9.1	42.0
44.0		9.8/43.8m	9.5	9.2	9.0	8.8	8.6	8.4	44.0
46.0			8.8	8.6	8.3	8.1	7.9	7.7	46.0
48.0			8.7/46.5m	8.0	7.7	7.5	7.3	7.0	48.0
50.0				7.7/49.1m	7.1	6.9	6.7	6.5	50.0
52.0					6.7/51.7m	6.4	6.2	5.9	52.0
54.0						5.9	5.7	5.3	54.0
56.0						5.9/54.4m	5.2	4.8	56.0
58.0							5.0/57.0m	4.4	58.0
60.0								4.0/59.7m	60.0

表中の太線で囲まれた部分は、ブーム等の強度によって定められた値です。

▶ヘビイ補助シーブ(66.6tウエイト、主フックなし)

(単位:t)

ブーム長さ 作業半径 m	15.2	18.3	21.3	24.4	27.4	30.5	33.5	36.6	39.6	42.7	ブーム長さ 作業半径 m
5.0	13.5/5.2m	13.5/5.7m									
6.0	13.5	13.5	13.5/6.2m	13.5/6.8m							6.0
7.0	13.5	13.5	13.5	13.5	13.5/7.3m	13.5/7.8m					7.0
8.0	13.5	13.5	13.5	13.5	13.5	13.5	13.5/8.4m	13.5/8.9m			8.0
9.0	13.5	13.5	13.5	13.5	13.5	13.5	13.5	13.5	13.5/9.4m	13.5/9.9m	9.0
10.0	13.5	13.5	13.5	13.5	13.5	13.5	13.5	13.5	13.5	13.5	10.0
12.0	13.5	13.5	13.5	13.5	13.5	13.5	13.5	13.5	13.5	13.5	12.0
14.0	13.5	13.5	13.5	13.5	13.5	13.5	13.5	13.5	13.5	13.5	14.0
16.0	13.5	13.5	13.5	13.5	13.5	13.5	13.5	13.5	13.5	13.5	16.0
18.0	13.5/16.1m	13.5	13.5	13.5	13.5	13.5	13.5	13.5	13.5	13.5	18.0
20.0		13.5/18.7m	13.5	13.5	13.5	13.5	13.5	13.5	13.5	13.5	20.0
22.0			13.5/21.4m	13.5	13.5	13.5	13.5	13.5	13.5	13.5	22.0
24.0				13.5/24.0m	13.5	13.5	13.5	13.5	13.5	13.5	24.0
26.0					13.5	13.5	13.5	13.5	13.5	13.5	26.0
28.0					13.5/26.7m	13.5	13.5	13.5	13.5	13.5	28.0
30.0						13.5/29.3m	13.5	13.5	13.5	13.5	30.0
32.0							13.5/31.9m	13.5	13.5	13.5	32.0
34.0								13.5	13.5	13.5	34.0
36.0								13.5/34.6m	13.5	13.4	36.0
38.0									12.0/37.2m	12.4	38.0
40.0										11.4/39.9m	40.0

(単位:t)

ブーム長さ 作業半径 m	45.7	48.8	51.8	54.9	57.9	61.0	64.0	67.1	ブーム長さ 作業半径 m
10.0	13.5/10.5m	13.5/11.0m	13.5/11.5m						10.0
12.0	13.5	13.5	13.5	13.5/12.1m	13.5/12.6m	13.5/13.1m	13.5/13.7m		12.0
14.0	13.5	13.5	13.5	13.5	13.5	13.5	13.5	13.5/14.2m	14.0
16.0	13.5	13.5	13.5	13.5	13.5	13.5	13.5	13.5	16.0
18.0	13.5	13.5	13.5	13.5	13.5	13.5	13.5	13.5	18.0
20.0	13.5	13.5	13.5	13.5	13.5	13.5	13.5	13.5	20.0
22.0	13.5	13.5	13.5	13.5	13.5	13.5	13.5	13.5	22.0
24.0	13.5	13.5	13.5	13.5	13.5	13.5	13.5	13.5	24.0
26.0	13.5	13.5	13.5	13.5	13.5	13.5	13.5	13.5	26.0
28.0	13.5	13.5	13.5	13.5	13.5	13.5	13.5	13.5	28.0
30.0	13.5	13.5	13.5	13.5	13.5	13.5	13.5	13.5	30.0
32.0	13.5	13.5	13.5	13.5	13.5	13.5	13.5	13.5	32.0
34.0	13.5	13.5	13.5	13.5	13.5	13.3	13.1	12.9	34.0
36.0	13.1	12.9	12.7	12.5	12.3	12.1	11.9	11.7	36.0
38.0	12.1	11.9	11.6	11.5	11.2	11.0	10.9	10.6	38.0
40.0	11.2	11.0	10.7	10.5	10.3	10.1	9.9	9.7	40.0
42.0	10.3	10.1	9.9	9.7	9.4	9.2	9.1	8.8	42.0
44.0	10.1/42.5m	9.2	9.2	8.9	8.7	8.5	8.3	8.1	44.0
46.0		8.7/45.1m	8.5	8.3	8.0	7.8	7.6	7.4	46.0
48.0			7.8/47.8m	7.7	7.4	7.2	7.0	6.7	48.0
50.0				7.1	6.8	6.6	6.4	6.2	50.0
52.0				6.9/50.4m	6.2	6.1	5.9	5.6	52.0
54.0					5.9/53.1m	5.6	5.4	5.0	54.0
56.0						5.2/55.7m	4.9	4.5	56.0
58.0							4.5	4.1	58.0
60.0							4.3/58.3m	3.7	60.0
62.0								3.5/61.0m	62.0

表中の太線で囲まれた部分は、ブーム等の強度によって定められた値です。

▶ ロング主ブーム (66.6tウエイト)

(単位:t)

ブーム長さ 作業 半径 m	ブーム長さ m	70.1	73.2	76.2	79.2	82.3	85.3	88.4	ブーム長さ 作業 半径 m
12.0	37.5/13.9m								12.0
14.0	37.5	37.5/14.4m	34.0/14.9m	32.2/15.4m					14.0
16.0	36.0	35.9	33.0	31.6	31.0/16.0m	25.0/16.5m	25.0/17.0m		16.0
18.0	34.4	34.3	31.2	29.9	29.2	25.0	24.9		18.0
20.0	31.0	30.9	29.7	28.4	27.7	25.0	23.4		20.0
22.0	27.2	27.1	27.0	26.9	26.4	25.0	22.1		22.0
24.0	24.0	23.9	23.8	23.7	23.6	23.5	20.9		24.0
26.0	21.4	21.3	21.2	21.1	21.0	20.9	19.9		26.0
28.0	19.3	19.2	19.1	19.0	18.9	18.8	18.7		28.0
30.0	17.4	17.3	17.2	17.1	17.0	16.9	16.8		30.0
32.0	15.9	15.8	15.7	15.6	15.5	15.4	15.3		32.0
34.0	14.5	14.4	14.3	14.2	14.1	14.0	13.9		34.0
36.0	13.3	13.2	13.1	13.0	12.9	12.8	12.7		36.0
38.0	12.2	12.1	12.0	11.9	11.8	11.7	11.6		38.0
40.0	11.3	11.2	11.1	11.0	10.9	10.8	10.7		40.0
42.0	10.4	10.3	10.2	10.1	10.0	9.9	9.8		42.0
44.0	9.7	9.5	9.4	9.3	9.2	9.1	9.0		44.0
46.0	9.0	8.9	8.7	8.6	8.5	8.4	8.3		46.0
48.0	8.3	8.2	8.1	8.0	7.9	7.8	7.7		48.0
50.0	7.8	7.6	7.5	7.4	7.3	7.2	7.1		50.0
52.0	7.2	7.1	7.0	6.9	6.8	6.7	6.6		52.0
54.0	6.8	6.6	6.5	6.4	6.3	6.2	6.1		54.0
56.0	6.3	6.2	6.1	6.0	5.9	5.8	5.7		56.0
58.0	5.9	5.8	5.7	5.6	5.5	5.4	5.3		58.0
60.0	5.6	5.4	5.3	5.2	5.1	5.0	4.9		60.0
62.0	5.2	5.1	4.9	4.8	4.6	4.5	4.4		62.0
64.0	5.2/62.3m	4.7	4.5	4.4	4.2	4.1	4.0		64.0
66.0		4.5/64.9m	4.1	4.0	3.9	3.8	3.7		66.0
68.0			3.9/67.5m	3.7	3.6	3.5	3.4		68.0
70.0				3.4/70.0m	3.2	3.1	3.0		70.0
72.0					3.0	2.9	2.8		72.0
74.0					2.8/72.8m	2.7	2.6		74.0
76.0						2.6/75.5m	2.4/76.0m		76.0

表中の太線で囲まれた部分は、ブーム等の強度によって定められた値です。

▶ ロング補助シーブ (66.6tウエイト、主フックなし)

(単位:t)

ブーム長さ 作業 半径 m	ブーム長さ m	70.1	73.2	76.2	79.2	82.3	85.3	ブーム長さ 作業 半径 m
14.0	13.5/14.6m	13.5/15.1m	13.5/15.6m					14.0
16.0	13.5	13.5	13.5	13.5/16.1m	13.5/16.7m	13.5/17.2m		16.0
18.0	13.5	13.5	13.5	13.5	13.5	13.5		18.0
20.0	13.5	13.5	13.5	13.5	13.5	13.5		20.0
22.0	13.5	13.5	13.5	13.5	13.5	13.5		22.0
24.0	13.5	13.5	13.5	13.5	13.5	13.5		24.0
26.0	13.5	13.5	13.5	13.5	13.5	13.5		26.0
28.0	13.5	13.5	13.5	13.5	13.5	13.5		28.0
30.0	13.5	13.5	13.5	13.5	13.5	13.5		30.0
32.0	13.5	13.5	13.5	13.5	13.5	13.5		32.0
34.0	13.5	13.5	13.5	13.5	13.5	13.5		34.0
36.0	13.0	12.9	12.8	12.7	12.6	12.5		36.0
38.0	11.9	11.8	11.7	11.6	11.5	11.4		38.0
40.0	11.0	10.9	10.8	10.7	10.6	10.5		40.0
42.0	10.1	10.0	9.9	9.8	9.7	9.6		42.0
44.0	9.4	9.2	9.1	9.0	8.9	8.8		44.0
46.0	8.7	8.6	8.4	8.3	8.2	8.1		46.0
48.0	8.0	7.9	7.8	7.7	7.6	7.5		48.0
50.0	7.5	7.3	7.2	7.1	7.0	6.9		50.0
52.0	6.9	6.8	6.7	6.6	6.5	6.4		52.0
54.0	6.5	6.3	6.2	6.1	6.0	5.9		54.0
56.0	6.0	5.9	5.8	5.7	5.6	5.5		56.0
58.0	5.6	5.5	5.4	5.3	5.2	5.1		58.0
60.0	5.3	5.1	5.0	4.9	4.8	4.7		60.0
62.0	4.9	4.8	4.6	4.5	4.3	4.2		62.0
64.0	4.6/63.5m	4.4	4.2	4.1	3.9	3.8		64.0
66.0		4.0/66.0m	3.8	3.7	3.6	3.5		66.0
68.0			3.4	3.4	3.3	3.2		68.0
70.0			3.3/68.7m	3.1	2.9	2.8		70.0
72.0				2.9/71.4m	2.7	2.6		72.0
74.0					2.5/74.0m	2.4/74.0m		74.0

表中の太線で囲まれた部分は、ブーム等の強度によって定められた値です。

▶ライト主ブーム(66.6tウエイト)

(単位:t)

ブーム長さ 作業半径 m	18.3	21.3	24.4	27.4	30.5	33.5	36.6	39.6	42.7	45.7	ブーム長さ 作業半径 m
5.0	150.0/5.0m	149.6/5.5m									5.0
6.0	150.0	149.6	149.3/6.0m	133.6/6.6m							6.0
7.0	136.6	136.2	135.9	130.8	119.7/7.1m	100.0/7.6m					7.0
8.0	115.0	114.6	114.3	114.1	113.8	100.0	98.0/8.2m	89.5/8.7m			8.0
9.0	100.3	100.1	99.9	99.8	99.6	99.4	95.0	88.5	81.7/9.2m	75.0/9.7m	9.0
10.0	85.3	85.1	84.9	84.8	84.6	84.5	84.3	84.0	79.6	74.5	10.0
12.0	65.5	65.3	65.0	64.9	64.7	64.6	64.5	64.3	64.2	64.0	12.0
14.0	53.0	52.7	52.5	52.3	52.1	52.0	51.9	51.6	51.5	51.3	14.0
16.0	44.4	44.1	43.8	43.6	43.4	43.3	43.2	42.9	42.8	42.6	16.0
18.0	39.7/17.4m	37.8	37.5	37.3	37.1	36.9	36.8	36.5	36.4	36.2	18.0
20.0		33.0	32.7	32.5	32.2	32.1	32.0	31.7	31.5	31.3	20.0
22.0		32.9/20.1m	28.9	28.7	28.4	28.3	28.1	27.8	27.7	27.5	22.0
24.0			27.8/22.7m	25.7	25.4	25.2	25.1	24.7	24.6	24.4	24.0
26.0				25.4m/24.0	22.9	22.7	22.5	22.2	22.1	21.8	26.0
28.0					20.8/28.0m	20.6	20.4	20.1	19.9	19.7	28.0
30.0						18.8	18.6	18.3	18.1	17.9	30.0
32.0						18.3/30.6m	17.1	16.7	16.6	16.3	32.0
34.0							16.2/33.3m	15.4	15.2	15.0	34.0
36.0								14.3/35.9m	14.1	13.8	36.0
38.0									13.0	12.8	38.0
40.0									12.8/38.6m	11.9	40.0
42.0										11.4/41.2m	42.0

(単位:t)

ブーム長さ 作業半径 m	48.8	51.8	54.9	57.9	61.0	64.0	67.1	ブーム長さ 作業半径 m
10.0	68.7/10.3m	63.3/10.8m	58.2/11.3m	53.6/11.9m				10.0
12.0	63.9	61.3	57.1	53.4	49.5/12.4m	45.3/12.9m	41.7/13.5m	12.0
14.0	51.2	51.0	50.7	50.5	47.3	43.9	41.0	14.0
16.0	42.5	42.3	42.2	42.0	41.8	41.5	38.7	16.0
18.0	36.1	35.9	35.8	35.5	35.3	35.0	34.8	18.0
20.0	31.2	31.0	30.9	30.6	30.4	30.2	30.1	20.0
22.0	27.3	27.1	27.0	26.8	26.6	26.5	26.3	22.0
24.0	24.2	24.0	23.9	23.7	23.4	23.3	23.1	24.0
26.0	21.7	21.4	21.3	21.1	20.9	20.8	20.5	26.0
28.0	19.5	19.3	19.2	18.9	18.7	18.6	18.4	28.0
30.0	17.7	17.5	17.4	17.1	16.9	16.8	16.5	30.0
32.0	16.1	15.9	15.8	15.5	15.3	15.2	14.9	32.0
34.0	14.8	14.5	14.4	14.1	13.9	13.8	13.6	34.0
36.0	13.6	13.3	13.2	12.9	12.7	12.6	12.4	36.0
38.0	12.5	12.3	12.2	11.9	11.7	11.6	11.3	38.0
40.0	11.6	11.4	11.2	10.9	10.7	10.6	10.3	40.0
42.0	10.8	10.5	10.4	10.1	9.9	9.8	9.5	42.0
44.0	10.1/43.8m	9.8	9.7	9.4	9.1	9.0	8.7	44.0
46.0		9.1	9.0	8.7	8.4	8.3	8.0	46.0
48.0		9.0/46.5m	8.4	8.1	7.8	7.7	7.4	48.0
50.0			8.1/49.1m	7.5	7.3	7.1	6.8	50.0
52.0				7.1/51.8m	6.8	6.6	6.3	52.0
54.0					6.3	6.1	5.8	54.0
56.0					6.2/54.4m	5.7	5.3	56.0
58.0						5.5/57.0m	4.9	58.0
60.0							4.5/59.7m	60.0

表中の太線で囲まれた部分は、ブーム等の強度によって定められた値です。

▶ライト補助シーブ(66.6tウエイト、主フックなし)

(単位:t)

作業半径m	ブーム長さm	18.3	21.3	24.4	27.4	30.5	33.5	36.6	39.6	42.7	45.7	ブーム長さm	作業半径m
5.0	13.5/5.7m												
6.0	13.5	13.5/6.2m	13.5/6.8m										6.0
7.0	13.5	13.5	13.5	13.5/7.3m	13.5/7.8m								7.0
8.0	13.5	13.5	13.5	13.5	13.5	13.5/8.4m	13.5/8.9m						8.0
9.0	13.5	13.5	13.5	13.5	13.5	13.5	13.5	13.5/9.4m	13.5/9.9m				9.0
10.0	13.5	13.5	13.5	13.5	13.5	13.5	13.5	13.5	13.5	13.5/10.5m			10.0
12.0	13.5	13.5	13.5	13.5	13.5	13.5	13.5	13.5	13.5	13.5	13.5		12.0
14.0	13.5	13.5	13.5	13.5	13.5	13.5	13.5	13.5	13.5	13.5	13.5		14.0
16.0	13.5	13.5	13.5	13.5	13.5	13.5	13.5	13.5	13.5	13.5	13.5		16.0
18.0	13.5	13.5	13.5	13.5	13.5	13.5	13.5	13.5	13.5	13.5	13.5		18.0
20.0	13.5/18.7m	13.5	13.5	13.5	13.5	13.5	13.5	13.5	13.5	13.5	13.5		20.0
22.0		13.5/21.4m	13.5	13.5	13.5	13.5	13.5	13.5	13.5	13.5	13.5		22.0
24.0			13.5/24.0m	13.5	13.5	13.5	13.5	13.5	13.5	13.5	13.5		24.0
26.0				13.5	13.5	13.5	13.5	13.5	13.5	13.5	13.5		26.0
28.0				13.5/26.7m	13.5	13.5	13.5	13.5	13.5	13.5	13.5		28.0
30.0					13.5/29.3m	13.5	13.5	13.5	13.5	13.5	13.5		30.0
32.0						13.5/31.9m	13.5	13.5	13.5	13.5	13.5		32.0
34.0							13.5	13.5	13.5	13.5	13.5		34.0
36.0							13.5/34.6m	13.5	13.5	13.5	13.5		36.0
38.0								13.4/37.2m	12.7	12.5			38.0
40.0									11.8/39.9m	11.6			40.0
42.0										10.8			42.0
44.0										10.6/42.5m			44.0

(単位:t)

作業半径m	ブーム長さm	48.8	51.8	54.9	57.9	61.0	64.0	67.1	ブーム長さm	作業半径m
10.0	13.5/11.0m	13.5/11.5m								10.0
12.0	13.5	13.5	13.5/12.1m	13.5/12.6m	13.5/13.1m	13.5/13.7m				12.0
14.0	13.5	13.5	13.5	13.5	13.5	13.5	13.5/14.2m			14.0
16.0	13.5	13.5	13.5	13.5	13.5	13.5	13.5			16.0
18.0	13.5	13.5	13.5	13.5	13.5	13.5	13.5			18.0
20.0	13.5	13.5	13.5	13.5	13.5	13.5	13.5			20.0
22.0	13.5	13.5	13.5	13.5	13.5	13.5	13.5			22.0
24.0	13.5	13.5	13.5	13.5	13.5	13.5	13.5			24.0
26.0	13.5	13.5	13.5	13.5	13.5	13.5	13.5			26.0
28.0	13.5	13.5	13.5	13.5	13.5	13.5	13.5			28.0
30.0	13.5	13.5	13.5	13.5	13.5	13.5	13.5			30.0
32.0	13.5	13.5	13.5	13.5	13.5	13.5	13.5			32.0
34.0	13.5	13.5	13.5	13.5	13.5	13.5	13.5	13.3		34.0
36.0	13.3	13.0	12.9	12.6	12.4	12.3	12.1			36.0
38.0	12.2	12.0	11.9	11.6	11.4	11.3	11.0			38.0
40.0	11.3	11.1	10.9	10.6	10.4	10.3	10.0			40.0
42.0	10.5	10.2	10.1	9.8	9.6	9.5	9.2			42.0
44.0	9.8	9.5	9.4	9.1	8.8	8.7	8.4			44.0
46.0	9.5/45.1m	8.8	8.7	8.4	8.1	8.0	7.7			46.0
48.0		8.2/47.8m	8.1	7.8	7.5	7.4	7.1			48.0
50.0			7.5	7.2	7.0	6.8	6.5			50.0
52.0			7.4/50.4m	6.8	6.5	6.3	6.0			52.0
54.0				6.5/53.1m	6.0	5.8	5.5			54.0
56.0					5.6/55.7m	5.4	5.0			56.0
58.0						5.0	4.6			58.0
60.0						4.9/58.3m	4.2			60.0
62.0							4.0/61.0m			62.0

表中の太線で囲まれた部分は、ブーム等の強度によって定められた値です。

▶ラッピングタワー全体図(単位：mm)

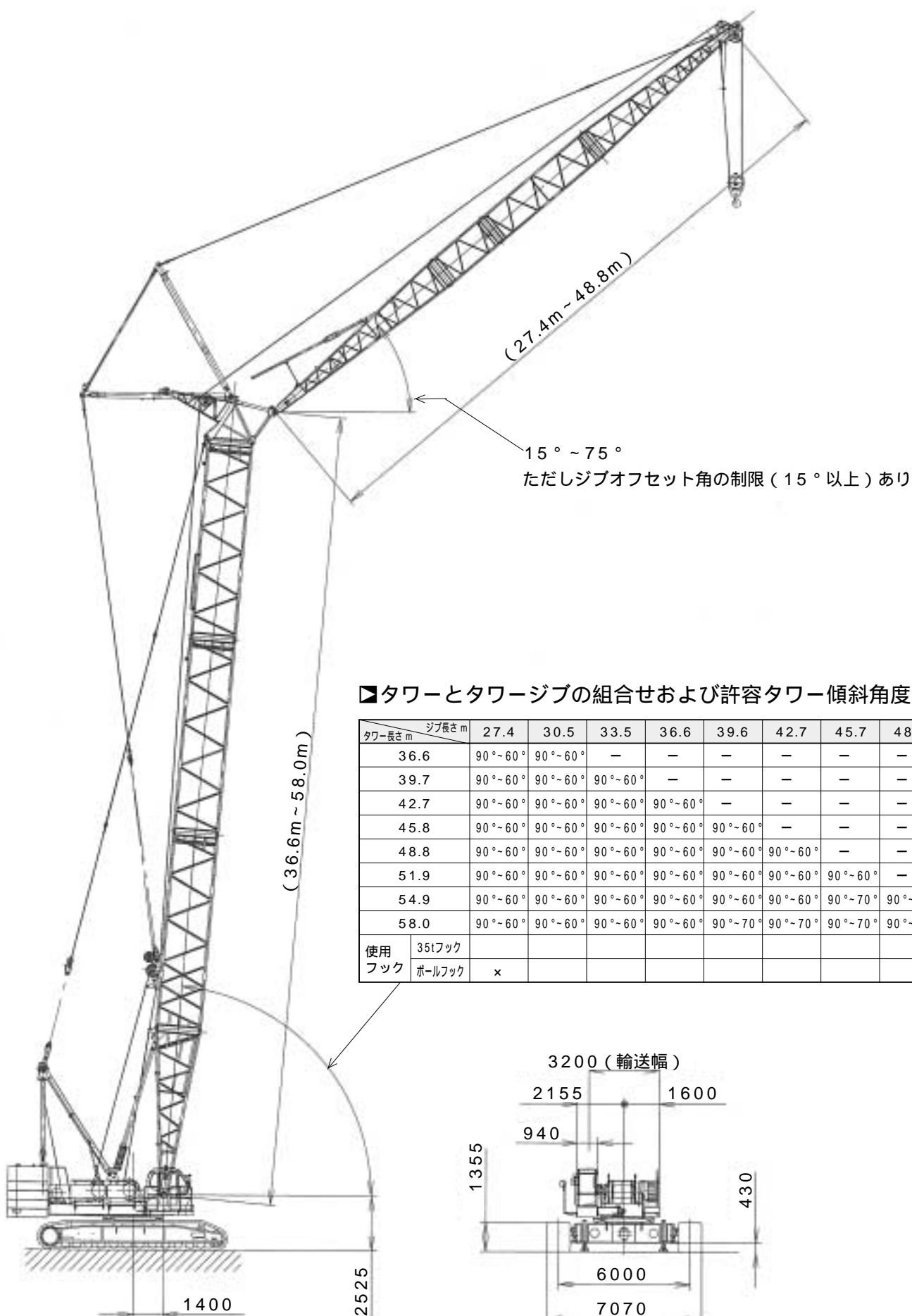

▶タワーとタワージブの組合せおよび許容タワー傾斜角度

タワー長さ m	ジブ長さ m	27.4	30.5	33.5	36.6	39.6	42.7	45.7	48.8	敷板
36.6	90°~60°	90°~60°	—	—	—	—	—	—	—	—
39.7	90°~60°	90°~60°	90°~60°	—	—	—	—	—	—	—
42.7	90°~60°	90°~60°	90°~60°	90°~60°	—	—	—	—	—	—
45.8	90°~60°	90°~60°	90°~60°	90°~60°	90°~60°	—	—	—	—	—
48.8	90°~60°	90°~60°	90°~60°	90°~60°	90°~60°	90°~60°	—	—	—	—
51.9	90°~60°	90°~60°	90°~60°	90°~60°	90°~60°	90°~60°	90°~60°	—	—	—
54.9	90°~60°	90°~60°	90°~60°	90°~60°	90°~60°	90°~60°	90°~70°	90°~70°	—	—
58.0	90°~60°	90°~60°	90°~60°	90°~60°	90°~70°	90°~70°	90°~70°	90°~70°	—	—
使用フック	35tフック									
	ボールフック	x								

▶タワーおよびタワージブ構成

- 使用するガイラインの径は 34mmです。
- は、これより短いタワーおよびタワージブの組立可能な構成を示します。
- タワー用 **B** をクローラークレーンの中間ブームに転用することも可能です。

●中間タワーブームの種類

記号	長さ	備考
3	3.0m	
6	6.1m	
9	9.1m	
B	9.1m	ガイドシーブ付





●中間タワージブの種類

記号	長さ	備考
C	3.0m	中継ジブ：下部タワージブとセットで使用
3	3.0m	
6	6.1m	
9	9.1m	

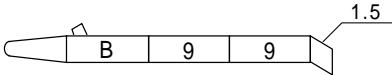
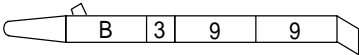
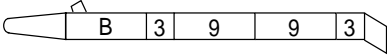
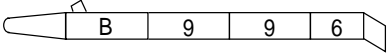
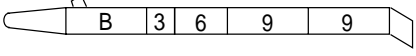
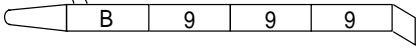
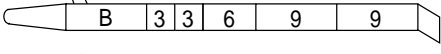
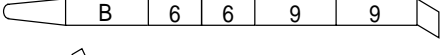
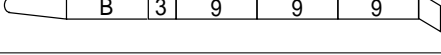
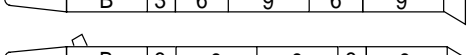
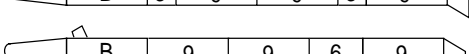

●タワー上部ジブ

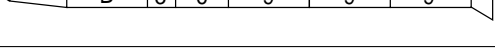
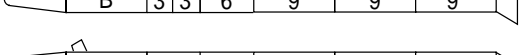
記号	長さ	備考
	8.3m	ロング上部ブームと兼用

▶タワー構成

ブーム長さm	タワー構成
36.6	
39.7	
42.7	 
45.8	 
48.8	  
51.9	  
54.9	
58.0	 

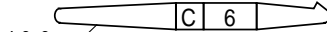
▶タワージブ構成

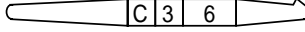
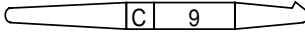
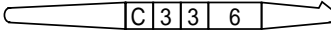
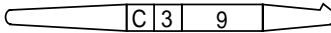
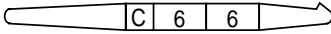
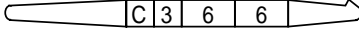
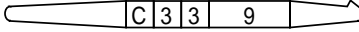
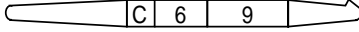
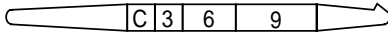
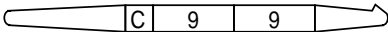
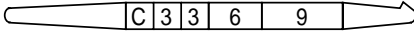
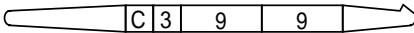
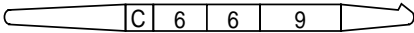
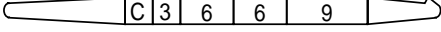
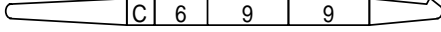
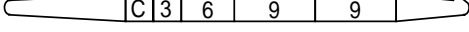
ブーム長さm	タワージブ構成
27.4	  10.0
30.5	 
33.5	  
36.6	  
39.6	 
42.7	  
45.7	 
48.8	

▶ 定格総荷重

- 定格総荷重とは、水平堅土上における転倒荷重の78%以内で、フックブロック、玉掛用ワイヤロープ等のつり具の質量を含んだ値です。
- 作業半径とはクレーン旋回中心よりつり上荷重の重心までの水平距離を意味します。
- 実際につり上げ得る荷重は定格総荷重から（主フック+玉掛用ワイヤロープ等のつり具）の質量を差し引いた値になります。
- 定格総荷重をつる場合にも風の影響、地盤の状態、作業速度その他安全作業に有害な状況がある時はオペレータは荷重の軽減、作業速度を遅くするなど状況に応じた判断をする責任があります。
- 表中の空欄の個所では作業を行うことができません。
- クレーン作業中にはガントリを最高位置に立ててください。

- すべてのタワー（ジブ）長さにおける中間タワーブーム（ジブ）の構成は取扱説明書の指示を厳守してください。
 - ジブ長さ27.4mにて13.5tボールフックの使用はできません。
 - 54.9mおよび58.0mタワーの自立、降下の際には、クローラの前端に敷板（ブロック）を敷いてください。
- △ 操作ミスなどによるつり荷の落下を防ぐため、クレーン作業では自由降下（フリーフォール）作業は行わないでください。

- 巻上げロープ巻掛本数に対する最大巻上荷重とフックの質量

フック呼称		35t	13.5t (ボールフック)
最大巻上 荷重(t)	1本掛	13.5	13.5
	2本掛	25.0	—
フック質量		0.9t	0.45t

▶ タワー長さ 36.6m

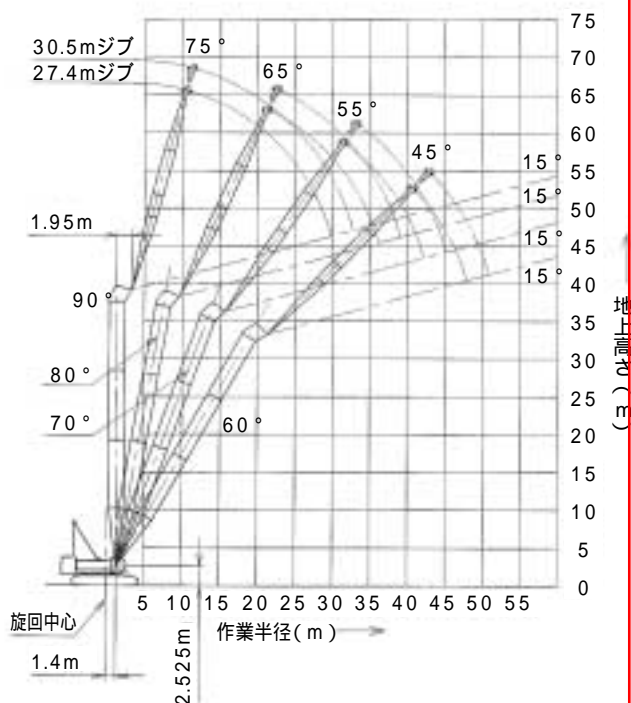

(単位:t)

タワー長さm	36.6							
	27.4				30.5			
	90°	80°	70°	60°	90°	80°	70°	60°
ジブ長さm	25.0/10.7m							
タワー角度	90°	80°	70°	60°	90°	80°	70°	60°
作業半径(m)	11.0	25.0			24.4/11.5m			
	12.0	25.0			24.2			
	13.0	25.0			24.0			
	14.0	25.0			23.8			
	15.0	24.8			23.6			
	16.0	24.6			23.4			
	18.0	24.2			23.0			
	20.0	23.8	19.0/21.5m		22.6			
	22.0	23.1	18.3		22.2	18.2/22.8m		
	24.0	19.9	16.3		20.3	16.2		
	26.0	17.1	14.8		17.7	14.7		
	28.0	14.1	13.4		15.5	13.3		
	30.0	10.2/29.9m	12.3	11.6/31.7m	13.4	12.2		
	32.0		11.4	11.4	10.5	11.3	10.5/33.5m	
	34.0		10.6	10.6	8.9/32.9m	10.5	10.4	
	36.0		9.9	9.9		9.8	9.7	
	38.0		9.8/36.3m	9.3		9.2	9.1	
	40.0			8.8	8.5/41.0m	8.9/39.2m	8.6	
	42.0			8.3	8.2		8.1	7.6/43.2m
	44.0			8.2/42.3m	7.7		7.6	7.4
46.0				7.2		7.5/45.3m	7.0	
48.0				6.7/48.0m			6.6	
50.0							6.2	
52.0							6.0/50.9m	

表中の大線で囲まれた部分は、ブーム等の強度によって定められた値です。

▶タワー長さ 39.7m

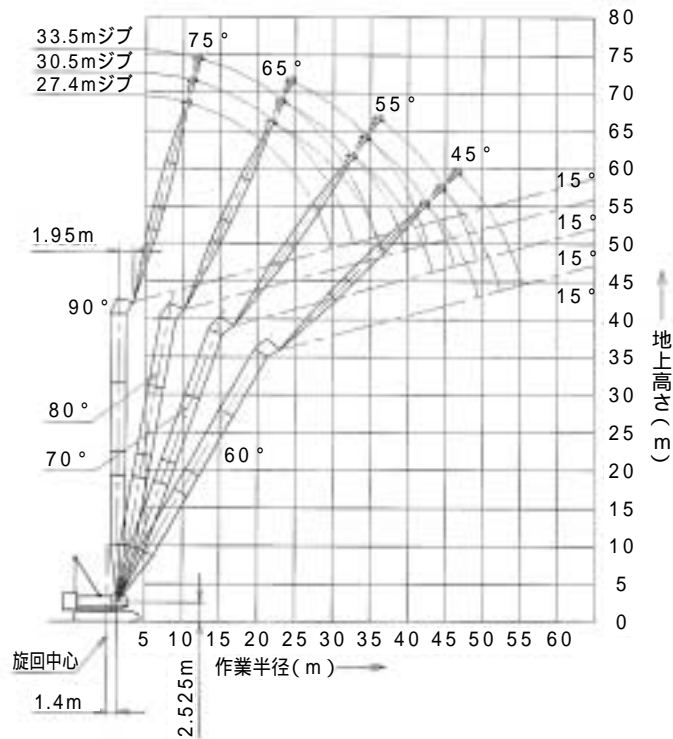

(単位:t)

タワー長さ m	39.7											
	27.4				30.5				33.5			
ジブ長さ m	27.4				30.5				33.5			
タワー角度	90°	80°	70°	60°	90°	80°	70°	60°	90°	80°	70°	60°
作業半径 (m)	11.0	25.0			24.4/11.5m				22.7/12.3m			
	12.0	25.0			24.2				22.5			
	13.0	25.0			24.0				22.3			
	14.0	25.0			23.8				22.1			
	15.0	24.8			23.6				21.9			
	16.0	24.6			23.4				21.5			
	18.0	24.2			23.0				21.1			
	20.0	23.8			22.6				20.7			
	22.0	23.1	18.3/22.1m		22.2	16.8/23.4m			20.3	15.7/24.6m		
	24.0	19.9	16.3		20.3	16.2			18.0	14.6		
	26.0	17.1	14.8		17.7	14.7			15.9	13.2		
	28.0	14.1	13.4		15.5	13.3			14.0	12.1		
	30.0	10.2/29.9m	12.3		13.4	12.2			12.3	11.2		
	32.0		11.4	11.0/32.8m	10.5	11.3			10.3	10.4		
	34.0		10.6	10.6	8.9/32.9m	10.5	10.4/34.5m		9.7	9.6/36.3m		
	36.0		9.9	9.9		9.8	9.7		7.8/35.8m	9.1	8.9	
	38.0		9.6/36.3m	9.3		9.2	9.1		8.6	8.4		
	40.0			8.8		8.8/39.7m	8.6		8.1	7.9		
	42.0			8.3	7.7/42.5m		8.1		7.4	7.4		
	44.0			7.9/43.4m	7.4		7.6	7.1/44.7m	7.0	6.6/46.8m		
46.0			7.0			7.2	6.9	6.6	6.4			
48.0			6.6/48.0m			7.1/46.3m	6.5	6.3/49.3m	6.0			
50.0							6.1	5.6	5.2			
52.0							5.7		4.9/55.4m			
54.0							5.6/52.4m					
56.0												

表中の太線で囲まれた部分は、ブーム等の強度によって定められた値です。

▶タワー長さ 42.7m

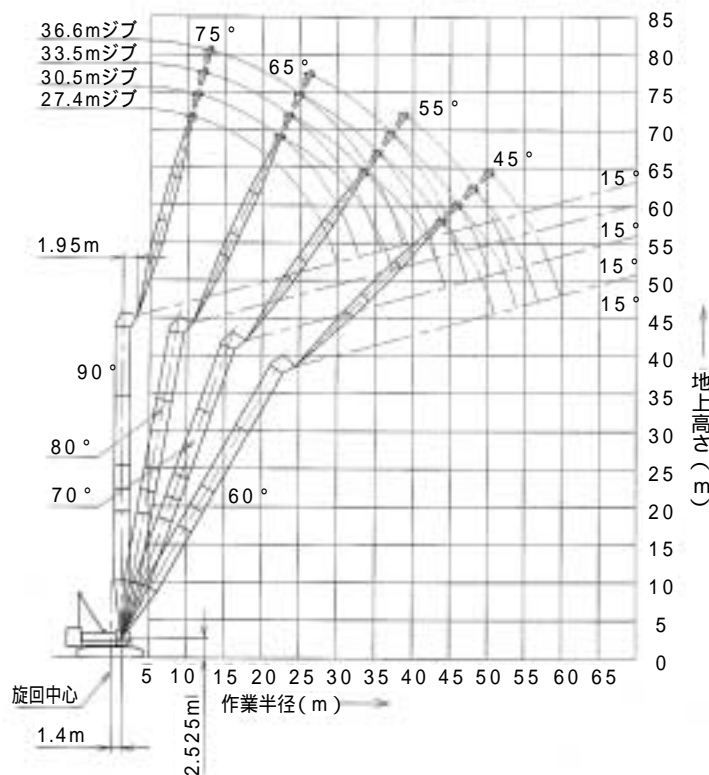

(単位:t)

タワー長さ m	42.7															
ジブ長さ m	27.4				30.5				33.5				36.6			
タワー角度	90°	80°	70°	60°	90°	80°	70°	60°	90°	80°	70°	60°	90°	80°	70°	60°
作業半径 (m)	11.0	25.0			24.4/11.5m											
	12.0	25.0			24.2				22.7/12.3m							
	13.0	25.0			24.0				22.5				21.0/13.1m			
	14.0	25.0			23.8				22.3				20.8			
	15.0	24.8			23.6				22.1				20.6			
	16.0	24.6			23.4				21.9				20.4			
	18.0	24.2			23.0				21.5				20.0			
	20.0	23.8			22.6				21.1				19.6			
	22.0	23.1	17.8/22.6m		22.2	16.2/23.9m			20.7				19.2			
	24.0	19.9	16.3		20.3	16.2			20.3	15.2/25.2m			18.8			
	26.0	17.1	14.8		17.7	14.7			18.0	14.6			18.3	14.1/26.5m		
	28.0	14.1	13.4		15.5	13.3			15.9	13.2			16.2	13.1		
	30.0	10.2/29.9m	12.3		13.4	12.2			14.0	12.1			14.4	12.0		
	32.0		11.4	10.7/33.8m		10.5	11.3			12.3	11.2			12.8	11.1	
	34.0		10.6	10.6		8.9/32.9m	10.5	9.8/35.6m		10.3	10.4			11.4	10.3	
	36.0		9.9	9.9			9.8	9.7		7.8/35.8m	9.7	9.1/37.3m		10.0	9.6	
	38.0		9.5/37.3m	9.3			9.2	9.1			9.1	8.9		8.0	9.0	8.5/39.1m
	40.0			8.8			8.7	8.6			8.6	8.4		6.9/38.8m	8.5	8.2
	42.0			8.3			8.6/40.3m	8.1			8.1	7.9			8.0	7.7
	44.0			7.8	7.0/44.1m			7.6			7.8/43.2m	7.4			7.5	7.2
46.0			7.7/44.4m	6.7			7.2	6.4/46.2m			7.0			7.1	6.8	
48.0				6.4			6.9/47.4m	6.2			6.6	5.9/48.4m		7.1/46.1m	6.4	
50.0				6.1				5.9			6.2	5.7		6.0	5.3/50.5m	
52.0				5.9/51.0m				5.6			6.2/50.3m	5.4			5.7	
54.0								5.3/54.0m				5.1			5.5/53.3m	
56.0												4.8			4.6	
58.0												4.6/56.9m			4.3	
60.0															4.0/59.9m	

表中の太線で囲まれた部分は、ブーム等の強度によって定められた値です。

▶タワー長さ 45.8m

(単位:t)

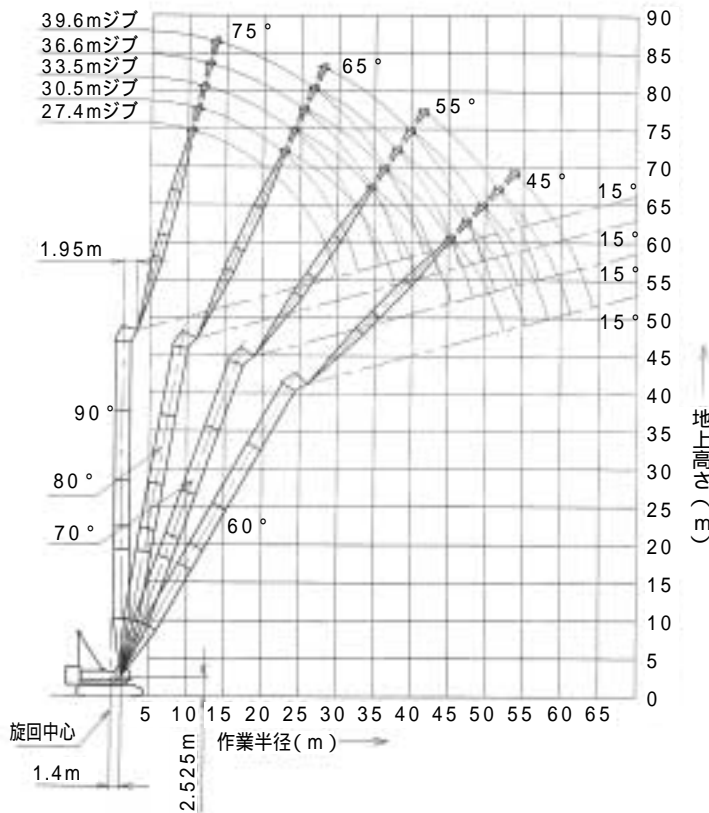

タワー長さm		45.8			
ジブ長さm		27.4			
タワー角度		90°	80°	70°	60°
作業半径(m)		25.0/10.7m			
	11.0	25.0			
	12.0	25.0			
	13.0	25.0			
	14.0	25.0			
	15.0	24.8			
	16.0	24.6			
	18.0	24.2			
	20.0	23.8			
	22.0	23.1	17.3/23.1m		
	24.0	19.9	16.3		
	26.0	17.1	14.8		
	28.0	14.1	13.4		
	30.0	10.2/29.9m	12.3		
	32.0		11.4		
	34.0		10.6	10.2/34.9m	
	36.0		9.9	9.9	
	38.0		9.3/37.8m	9.3	
	40.0			8.8	
	42.0			8.3	
44.0			7.8	6.6/45.6m	
46.0			7.5/45.5m	6.5	
48.0				6.2	
50.0				5.9	
52.0				5.6	
54.0				5.5/52.5m	

タワー長さm		45.8															
ジブ長さm		30.5				33.5				36.6				39.6			
タワー角度		90°	80°	70°	60°	90°	80°	70°	60°	90°	80°	70°	60°	90°	80°	70°	60°
作業半径(m)	11.0	24.4/11.5m															
	12.0	24.2				22.7/12.3m											
	13.0	24.0				22.5				21.0/13.1m				19.3/13.9m			
	14.0	23.8				22.3				20.8				19.3			
	15.0	23.6				22.1				20.6				19.1			
	16.0	23.4				21.9				20.4				18.9			
	18.0	23.0				21.5				20.0				18.5			
	20.0	22.6				21.1				19.6				18.1			
	22.0	22.2				20.7				19.2				17.7			
	24.0	20.3	16.0/24.4m			20.3	14.8/25.7m			18.8				17.3			
	26.0	17.7	14.7			18.0	14.6			18.3	13.8/27.0m			16.9			
	28.0	15.5	13.3			15.9	13.2			16.2	13.1			16.5	12.9/28.3m		
	30.0	13.4	12.2			14.0	12.1			14.4	12.0			14.6	11.9		
	32.0	10.5	11.3			12.3	11.2			12.8	11.1			13.0	11.0		
	34.0	8.9/32.9m	10.5			10.3	10.4			11.4	10.3			11.7	10.2		
	36.0		9.8	9.5/36.6m		7.8/35.8m	9.7			10.0	9.6			10.5	9.5		
	38.0		9.2	9.1			9.1	8.5/38.4m		8.0	9.0			9.4	8.9		
	40.0		8.7	8.6			8.6	8.4		6.9/38.8m	8.5	8.2/40.1m		8.0	8.4	7.6/41.9m	
	42.0		8.4/40.8m	8.1			8.1	7.9			8.0	7.7		6.1/41.7m	7.9	7.6	
	44.0			7.6			7.8/43.7m	7.4			7.5	7.2			7.4	7.1	
46.0			7.2	6.1/47.7m			7.0			7.1	6.8			7.0	6.7		
48.0			6.8	6.1			6.6	5.5/49.9m		7.0/46.7m	6.4			6.6	6.3		
50.0			6.7/48.4m	5.8			6.2	5.5			6.0			6.4/49.6m	5.9		
52.0				5.5			6.0/51.3m	5.3			5.7	5.0/52.0m			5.6		
54.0				5.2				5.0			5.5	4.8			5.4	4.6/54.2m	
56.0				4.9/55.5m				4.8			5.4/54.3m	4.6			5.1	4.4	
58.0								4.5				4.4			4.8/57.2m	4.2	
60.0								4.4/58.4m				4.2				4.0	
62.0												4.0/61.4m				3.8	
64.0																3.6	
66.0																3.5/64.3m	

表中の太線で囲まれた部分は、ブーム等の強度によって定められた値です。

▶タワー長さ 48.8m

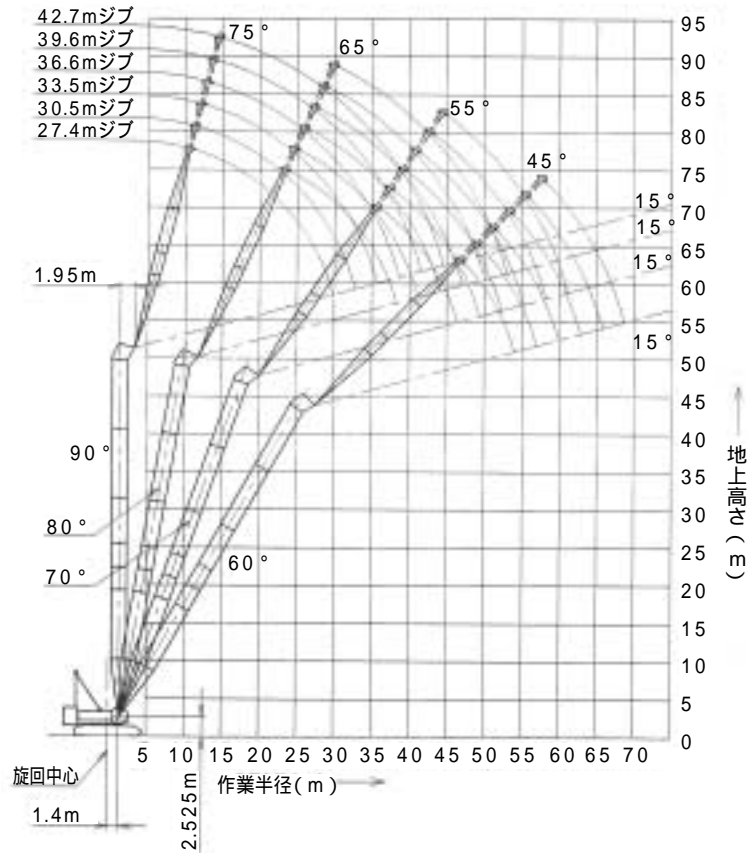

(単位:t)

タワー長さm	48.8							タワー長さm	
ジブ長さm	27.4			30.5				ジブ長さm	
タワー角度	90°	80°	70°	60°	90°	80°	70°	60°	タワー角度
作業半径(m)	25.0/10.7m								
	11.0	25.0			24.4/11.5m				11.0
	12.0	25.0			24.2				12.0
	13.0	25.0			24.0				13.0
	14.0	25.0			23.8				14.0
	15.0	24.8			23.6				15.0
	16.0	24.6			23.4				16.0
	18.0	24.2			23.0				18.0
	20.0	23.8			22.6				20.0
	22.0	23.1	16.6/23.7m		22.2				22.0
	24.0	19.9	16.3		20.3	15.4/24.9m			24.0
	26.0	17.1	14.8		17.7	14.7			26.0
	28.0	14.1	13.4		15.5	13.3			28.0
	30.0	10.2/29.9m	12.3		13.4	12.2			30.0
	32.0		11.4		10.5	11.3			32.0
	34.0		10.6	9.9/35.9m	8.9/32.9m	10.5			34.0
	36.0		9.9	9.9		9.8	9.2/37.7m		36.0
	38.0		9.3	9.3		9.2	9.1		38.0
	40.0		9.2/38.4m	8.8		8.7	8.6		40.0
	42.0			8.3		8.4/41.3m	8.1		42.0
44.0			7.8			7.6		44.0	
46.0			7.4	5.9/47.1m		7.2		46.0	
48.0			7.3/46.5m	5.9		6.8	5.3/49.3m	48.0	
50.0				5.6		6.5/49.4m	5.2	50.0	
52.0				5.3			5.0	52.0	
54.0				5.0			4.8	54.0	
56.0				5.0/54.1m			4.6	56.0	
58.0							4.5/57.0m	58.0	

タワー長さm	48.8								タワー長さm
ジブ長さm	33.5				36.6				ジブ長さm
タワー角度	90°	80°	70°	60°	90°	80°	70°	60°	タワー角度
12.0	22.7/12.3m								12.0
13.0	22.5				21.0/13.1m				13.0
14.0	22.3				20.8				14.0
15.0	22.1				20.6				15.0
16.0	21.9				20.4				16.0
18.0	21.5				20.0				18.0
20.0	21.1				19.6				20.0
22.0	20.7				19.2				22.0
24.0	20.3				18.8				24.0
26.0	18.0	14.5/26.2m			18.3	13.4/27.5m			26.0
28.0	15.9	13.2			16.2	13.1			28.0
30.0	14.0	12.1			14.4	12.0			30.0
32.0	12.3	11.2			12.8	11.1			32.0
34.0	10.3	10.4			11.4	10.3			34.0
36.0	7.8/35.8m	9.7			10.0	9.6			36.0
38.0		9.1	8.5/39.4m		8.0	9.0			38.0
40.0		8.6	8.4		6.9/38.8m	8.5	7.9/41.2m		40.0
42.0		8.1	7.9			8.0	7.7		42.0
44.0		7.6	7.4			7.5	7.2		44.0
46.0		7.5/44.3m	7.0			7.1	6.8		46.0
48.0			6.6			6.8/47.2m	6.4		48.0
50.0			6.2	5.0/51.4m			6.0		50.0
52.0			5.9	4.9			5.7	4.6/53.6m	52.0
54.0			5.8/52.4m	4.7			5.5	4.6	54.0
56.0				4.5			5.3/55.3m	4.4	56.0
58.0				4.3				4.2	58.0
60.0				4.1/60.0m				4.0	60.0
62.0								3.8	62.0
64.0								3.7/62.9m	64.0

タワー長さm	48.8								タワー長さm
ジブ長さm	39.6				42.7				ジブ長さm
タワー角度	90°	80°	70°	60°	90°	80°	70°	60°	タワー角度
13.0	19.3/13.9m								13.0
14.0	19.3				17.7/14.7m				14.0
15.0	19.1				17.5				15.0
16.0	18.9				17.3				16.0
18.0	18.5				16.9				18.0
20.0	18.1				16.5				20.0
22.0	17.7				16.1				22.0
24.0	17.3				15.7				24.0
26.0	16.9				15.3				26.0
28.0	16.5	12.5/28.8m			14.9				28.0
30.0	14.6	11.9			14.5	11.8/30.1m			30.0
32.0	13.0	11.0			13.1	10.9			32.0
34.0	11.7	10.2			11.8	10.1			34.0
36.0	10.5	9.5			10.6	9.4			36.0
38.0	9.4	8.9			9.5	8.8			38.0
40.0	8.0	8.4			8.6	8.3			40.0
42.0	6.1/41.7m	7.9	7.3/42.9m		7.6	7.8			42.0
44.0		7.4	7.1		6.1	7.3	6.8/44.6m		44.0
46.0		7.0	6.7		5.3/44.6m	6.9	6.6		46.0
48.0		6.6	6.3			6.5	6.2		48.0
50.0		6.3	5.9			6.2	5.8		50.0
52.0		6.3/50.1m	5.6			5.9	5.5		52.0
54.0			5.4	4.3/55.7m		5.8/53.1m	5.3		54.0
56.0			5.1	4.3			5.0	4.0/57.9m	56.0
58.0			4.8	4.1			4.7	4.0	58.0
60.0			4.8/58.3m	3.9			4.5	3.8	60.0
62.0				3.7			4.3/61.2m	3.6	62.0
64.0				3.5				3.4	64.0
66.0				3.3/65.8m				3.2	66.0
68.0								3.0	68.0
70.0								2.9/68.8m	70.0

表中の太線で囲まれた部分は、ブーム等の強度によって定められた値です。

▶タワー長さ 51.9m

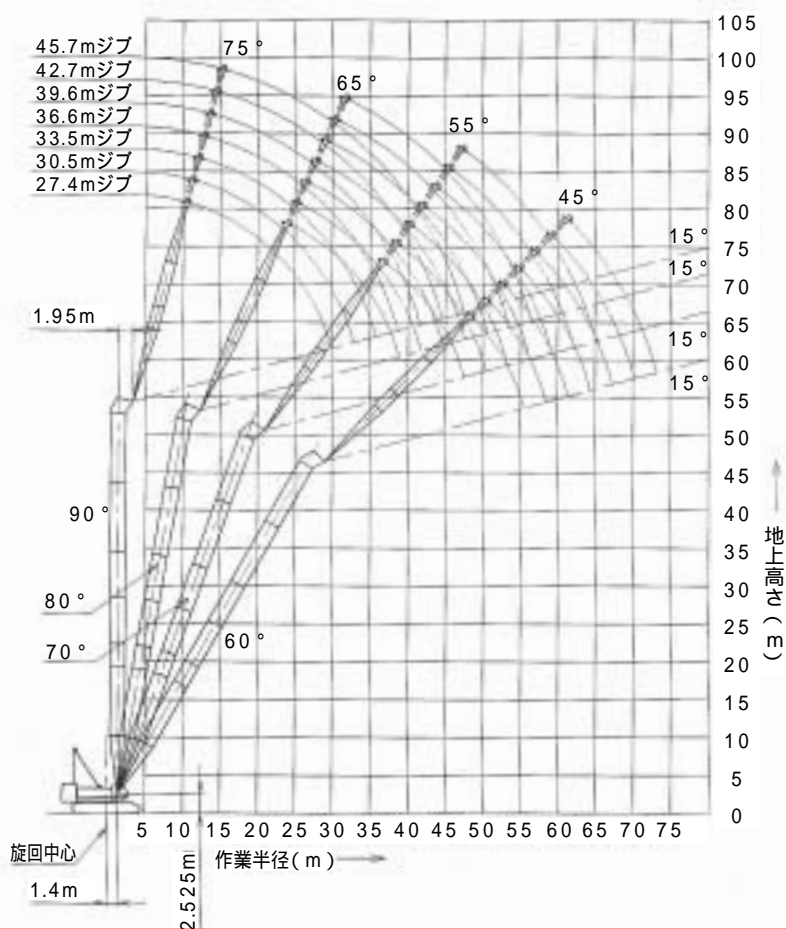

(単位:t)

タワー長さm		51.9												タワー長さm
ジブ長さm		27.4				30.5				33.5				ジブ長さm
タワー角度		90°	80°	70°	60°	90°	80°	70°	60°	90°	80°	70°	60°	タワー角度
作業半径(m)	11.0	25.0/10.7m				24.4/11.5m								11.0
	12.0	25.0				24.2				22.7/12.3m				12.0
	13.0	25.0				24.0				22.5				13.0
	14.0	25.0				23.8				22.3				14.0
	15.0	24.8				23.6				22.1				15.0
	16.0	24.6				23.4				21.9				16.0
	18.0	24.2				23.0				21.5				18.0
	20.0	23.8				22.6				21.1				20.0
	22.0	23.1				22.2				20.7				22.0
	24.0	19.9	16.2/24.2m			20.3	15.1/25.5m			20.3				24.0
	26.0	17.1	14.8			17.7	14.7			18.0	14.0/26.8m			26.0
	28.0	14.1	13.4			15.5	13.3			15.9	13.2			28.0
	30.0	10.2/29.9m	12.3			13.4	12.2			14.0	12.1			30.0
	32.0		11.4			10.5	11.3			12.3	11.2			32.0
	34.0		10.6			8.9/32.9m	10.5			10.3	10.4			34.0
	36.0		9.9	9.6/36.9m			9.8			7.8/35.8m	9.7			36.0
	38.0		9.3	9.3			9.2	8.9/38.7m			9.1			38.0
	40.0		8.8/38.9m	8.8			8.7	8.6			8.6	8.3/40.4m		40.0
	42.0			8.3			8.3/41.8m	8.1			8.1	7.9		42.0
	44.0			7.8				7.6			7.6	7.4		44.0
46.0			7.4				7.2			7.4/44.8m	7.0		46.0	
48.0			7.1/47.5m	5.4/48.6m			6.8				6.6		48.0	
50.0				5.3			6.4	4.9/50.8m			6.2		50.0	
52.0				5.1			6.3/50.5m	4.8			5.9	4.5/52.9m	52.0	
54.0				4.9				4.6			5.7/53.4m	4.4	54.0	
56.0				4.7/55.6m				4.4				4.2	56.0	
58.0								4.2				4.0	58.0	
60.0								4.1/58.5m				3.8	60.0	
62.0												3.5/61.5m	62.0	

タワー長さm	51.9								タワー長さm
ジブ長さm	36.6				39.6				ジブ長さm
タワー角度	90°	80°	70°	60°	90°	80°	70°	60°	タワー角度
13.0	21.0/13.1m				19.3/13.9m				13.0
14.0	20.8				19.3				14.0
15.0	20.6				19.1				15.0
16.0	20.4				18.9				16.0
18.0	20.0				18.5				18.0
20.0	19.6				18.1				20.0
22.0	19.2				17.7				22.0
24.0	18.8				17.3				24.0
26.0	18.3				16.9				26.0
28.0	16.2	13.1/28.1m			16.5	12.2/29.3m			28.0
30.0	14.4	12.0			14.6	11.9			30.0
32.0	12.8	11.1			13.0	11.0			32.0
34.0	11.4	10.3			11.7	10.2			34.0
36.0	10.0	9.6			10.5	9.5			36.0
38.0	8.0	9.0			9.4	8.9			38.0
40.0	6.9/38.8m	8.5			8.0	8.4			40.0
42.0		8.0	7.9/42.2m		6.1/41.7m	7.9	7.1/43.9m		42.0
44.0		7.5	7.7			7.4	7.1		44.0
46.0		7.1	7.2			7.0	6.7		46.0
48.0		6.8/47.7m	6.8			6.6	6.3		48.0
50.0			6.4			6.3	5.9		50.0
52.0			6.0			6.2/50.7m	5.6		52.0
54.0			5.7	4.2/55.1m			5.4		54.0
56.0			5.5	4.1			5.1	3.9/57.2m	56.0
58.0			5.1/56.4m	3.9			4.8	3.8	58.0
60.0				3.7			4.6/59.3m	3.6	60.0
62.0				3.5				3.4	62.0
64.0				3.3				3.2	64.0
66.0				3.2/64.4m				3.0	66.0
68.0								2.7/67.4m	68.0

タワー長さm	51.9								タワー長さm
ジブ長さm	42.7				45.7				ジブ長さm
タワー角度	90°	80°	70°	60°	90°	80°	70°	60°	タワー角度
14.0	17.7/14.7m				15.6/15.5m				14.0
15.0	17.5				15.5				15.0
16.0	17.3				15.1				16.0
18.0	16.9				14.7				18.0
20.0	16.5				14.3				20.0
22.0	16.1				13.9				22.0
24.0	15.7				13.5				24.0
26.0	15.3				13.1				26.0
28.0	14.9				12.7	10.8/31.9m			28.0
30.0	14.5	11.5/30.6m			12.3	10.0			30.0
32.0	13.1	10.9			11.9	10.0			32.0
34.0	11.8	10.1			10.7	9.3			34.0
36.0	10.6	9.4			9.7	8.7			36.0
38.0	9.5	8.8			8.8	8.2			38.0
40.0	8.6	8.3			7.9	7.7			40.0
42.0	7.6	7.8			7.1	7.2			42.0
44.0	6.1	7.3	6.7/45.7m		6.1	6.8	6.2/47.4m		44.0
46.0	5.3/44.6m	6.9	6.6		6.4	6.1			46.0
48.0		6.5	6.2		6.1	5.7			48.0
50.0		6.2	5.8		5.8	5.5			50.0
52.0		5.9	5.5		5.5	5.2			52.0
54.0		5.7/53.6m	5.3		5.2	4.9			54.0
56.0			5.0		4.6	4.6			56.0
58.0			4.7	3.6/59.4m	5.1/56.6m	4.4	3.2/61.6m		58.0
60.0			4.5	3.5		4.2	3.2		60.0
62.0			4.3	3.3		4.0	3.0		62.0
64.0			4.2/62.3m	3.1					64.0
66.0				2.9		3.9/65.2m	2.8		66.0
68.0				2.7			2.6		68.0
70.0				2.5			2.4		70.0
72.0				2.4/70.3m			2.2/72.0m		72.0

表中の太線で囲まれた部分は、ブーム等の強度によって定められた値です。

▶タワー長さ 54.9m

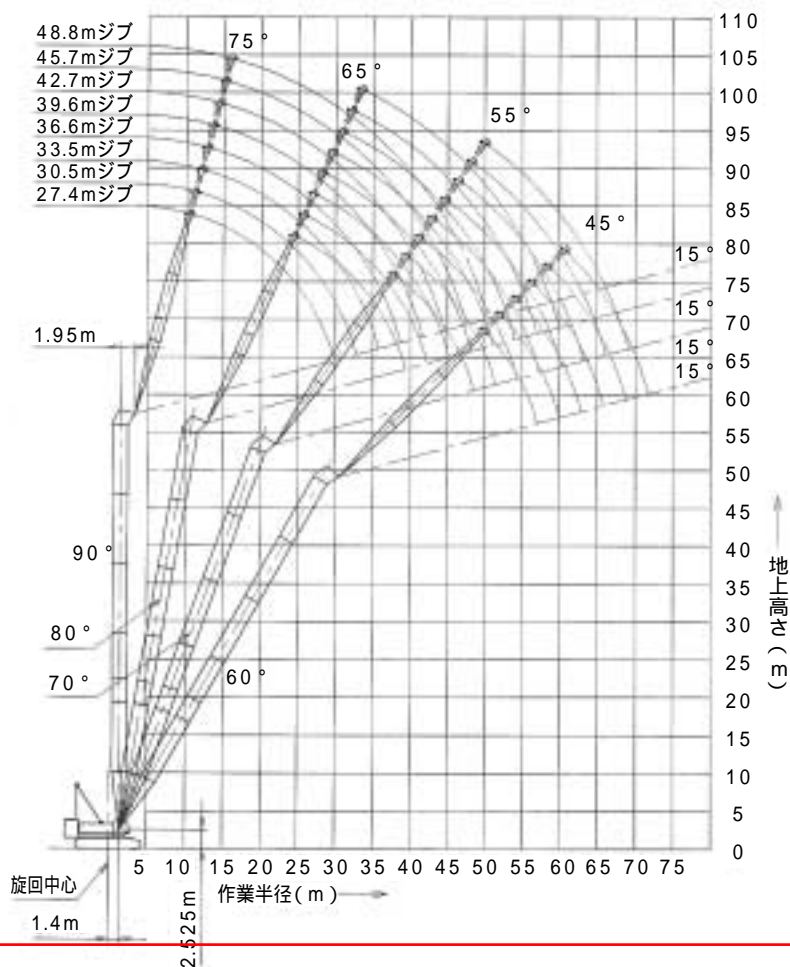

(単位:t)

タワー長さm	54.9												タワー長さm	
ジブ長さm	27.4				30.5				33.5				ジブ長さm	
タワー角度	90°	80°	70°	60°	90°	80°	70°	60°	90°	80°	70°	60°	タワー角度	
作業半径(m)	25.0/10.7m													
	11.0	25.0			24.4/11.5m									11.0
	12.0	25.0			24.2				22.7/12.3m					12.0
	13.0	25.0			24.0				22.5					13.0
	14.0	25.0			23.8				22.3					14.0
	15.0	24.8			23.6				22.1					15.0
	16.0	24.6			23.4				21.9					16.0
	18.0	24.2			23.0				21.5					18.0
	20.0	23.8			22.6				21.1					20.0
	22.0	23.1			22.2				20.7					22.0
	24.0	19.9	15.6/24.7m		20.3				20.3					24.0
	26.0	17.1	14.8		17.7	14.7/26.0m			18.0	13.7/27.3m				26.0
	28.0	14.1	13.4		15.5	13.3			15.9	13.2				28.0
	30.0	10.2/29.9m	12.3		13.4	12.2			14.0	12.1				30.0
	32.0		11.4		10.5	11.3			12.3	11.2				32.0
	34.0		10.6		8.9/32.9m	10.5			10.3	10.4				34.0
	36.0		9.9			9.8			7.8/35.8m	9.7				36.0
	38.0		9.3	9.3/38.0m		9.2	8.9/39.7m			9.1				38.0
	40.0		8.9/39.4m	8.8		8.7	8.6			8.6	8.0/41.5m			40.0
	42.0			8.3		8.2	8.1			8.1	7.9			42.0
44.0			7.8			8.0/42.4m	7.6		7.6	7.4			44.0	
46.0			7.4				7.2		7.3/45.3m	7.0			46.0	
48.0			7.0				6.8			6.6			48.0	
50.0			6.9/48.6m	5.1/50.2m			6.4			6.2			50.0	
52.0				4.9			6.2/51.5m	4.6/52.3m		5.9			52.0	
54.0				4.7				4.4		5.7	4.2/54.5m		54.0	
56.0				4.5				4.2		5.6/54.5m	4.0		56.0	
58.0				4.4/57.1m				4.0			3.8		58.0	
60.0								3.8			3.6		60.0	
62.0								3.8/60.1m				3.4	62.0	
64.0												3.3/63.0m	64.0	

タワー長さm	54.9												タワー長さm
ジブ長さm	36.6				39.6				42.7				ジブ長さm
タワー角度	90°	80°	70°	60°	90°	80°	70°	60°	90°	80°	70°	60°	タワー角度
13.0	21.0/13.1m				19.3/13.9m								13.0
14.0	20.8				19.3				17.7/14.7m				14.0
15.0	20.6				19.1				17.5				15.0
16.0	20.4				18.9				17.3				16.0
18.0	20.0				18.5				16.9				18.0
20.0	19.6				18.1				16.5				20.0
22.0	19.2				17.7				16.1				22.0
24.0	18.8				17.3				15.7				24.0
26.0	18.3				16.9				15.3				26.0
28.0	16.2	12.8/28.6m			16.5	11.9/29.9m			14.9				28.0
30.0	14.4	12.0			14.6	11.9			14.5	11.5/31.2m			30.0
32.0	12.8	11.1			13.0	11.0			13.1	10.9			32.0
34.0	11.4	10.3			11.7	10.2			11.8	10.1			34.0
36.0	10.0	9.6			10.5	9.5			10.6	9.4			36.0
38.0	8.0	9.0			9.4	8.9			9.5	8.8			38.0
40.0	6.9/38.8m	8.5			8.0	8.4			8.6	8.3			40.0
42.0		8.0	7.4/43.2m		6.1/41.7m	7.9			7.6	7.8			42.0
44.0		7.5	7.2			7.4	6.9/45.0m		6.1	7.3			44.0
46.0		7.1	6.8			7.0	6.7		5.3/44.6m	6.9	6.3/46.7m		46.0
48.0		6.7	6.4			6.6	6.3			6.5	6.2		48.0
50.0		6.7/48.3m	6.0			6.3	5.9			6.2	5.8		50.0
52.0			5.7			6.2/51.2m	5.6			5.9	5.5		52.0
54.0			5.5				5.4			5.6	5.3		54.0
56.0			5.2	3.9/56.6m			5.1			5.6/54.1m	5.0		56.0
58.0			5.0/57.4m	3.7			4.8	3.4/58.8m			4.7		58.0
60.0				3.5			4.6	3.3			4.5	2.9/60.9m	60.0
62.0				3.3			4.5/60.4m	3.1			4.3	2.8	62.0
64.0				3.1				2.9			4.1/63.3m	2.6	64.0
66.0				2.9/66.0m				2.7				2.4	66.0
68.0								2.5				2.2/68.0m	68.0
70.0								2.4/68.9m					70.0

タワー長さm	54.9						タワー長さm
ジブ長さm	45.7			48.8			ジブ長さm
タワー角度	90°	80°	70°	90°	80°	70°	タワー角度
15.0	15.6/15.5m						15.0
16.0	15.5			13.8/16.3m			16.0
18.0	15.1			13.4			18.0
20.0	14.7			13.0			20.0
22.0	14.3			12.6			22.0
24.0	13.9			12.2			24.0
26.0	13.5			11.8			26.0
28.0	13.1			11.4			28.0
30.0	12.7			11.0			30.0
32.0	12.3	10.7/32.4m		10.6	10.0/33.7m		32.0
34.0	11.9	10.0		10.2	9.9		34.0
36.0	10.7	9.3		9.8	9.2		36.0
38.0	9.7	8.7		9.4	8.6		38.0
40.0	8.8	8.2		8.9	8.1		40.0
42.0	7.9	7.7		8.0	7.6		42.0
44.0	7.1	7.2		7.3	7.1		44.0
46.0	6.1	6.8		6.6	6.7		46.0
48.0	4.7/47.6m	6.4	6.0/48.5m	5.8	6.3		48.0
50.0		6.1	5.7	4.7	6.0	5.6/50.2m	50.0
52.0		5.8	5.4	4.1/50.5m	5.7	5.3	52.0
54.0		5.5	5.2		5.4	5.0	54.0
56.0		5.2	4.9		5.1	4.7	56.0
58.0		5.0/57.1m	4.6		4.9	4.4	58.0
60.0			4.4		4.6/60.0m	4.2	60.0
62.0			4.2			3.9	62.0
64.0			4.0			3.7	64.0
66.0			3.8			3.5	66.0
68.0			3.7/66.3m			3.3	68.0
70.0						3.3/69.2m	70.0

表中の大線で囲まれた部分は、ブーム等の強度によって定められた値です。

▶タワー長さ 58.0m

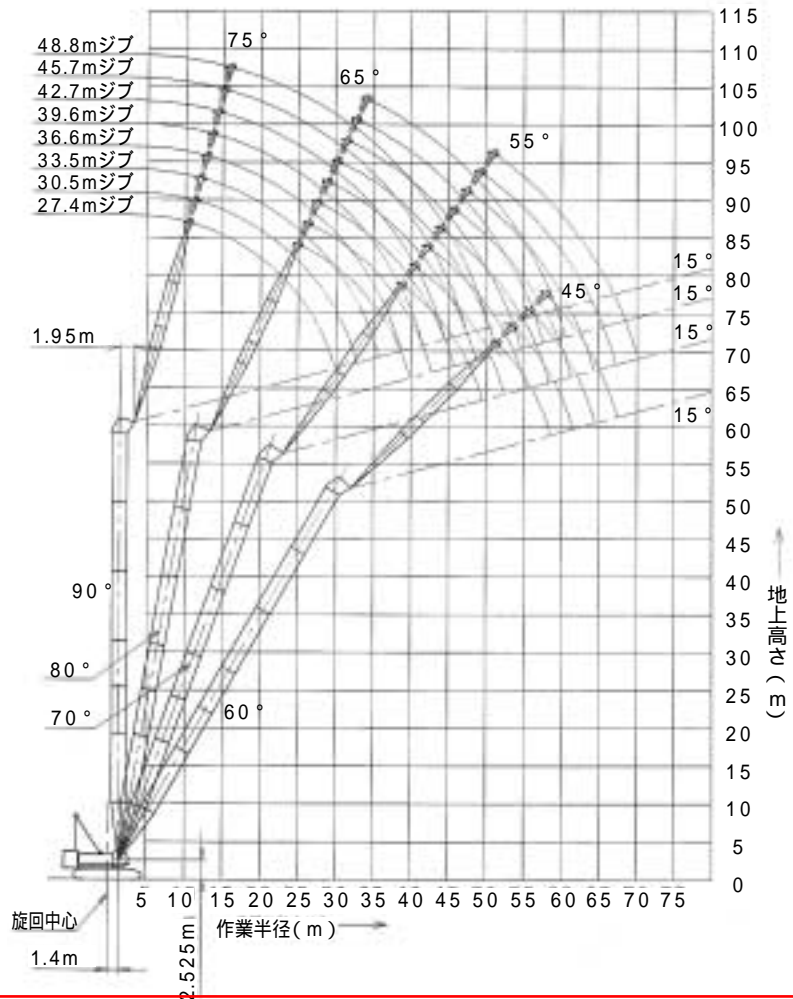

タワー長さm	58.0												タワー長さm
	27.4				30.5				33.5				
ジブ長さm													タワー角度
タワー角度	90°	80°	70°	60°	90°	80°	70°	60°	90°	80°	70°	60°	
11.0	25.0/10.7m												11.0
12.0	25.0				24.4/11.5m								12.0
13.0	25.0				24.2				22.7/12.3m				13.0
14.0	25.0				24.0				22.3				14.0
15.0	24.8				23.8				22.1				15.0
16.0	24.6				23.6				21.9				16.0
18.0	24.2				23.4				21.5				18.0
20.0	23.8				23.0				21.1				20.0
22.0	23.1				22.6				20.7				22.0
24.0	19.9	15.3/25.2m			22.2				20.3				24.0
26.0	17.1	14.8			20.3				18.0	13.3/27.8m			26.0
28.0	14.1	13.4			17.7	14.4/26.5m			15.9	13.2			28.0
30.0	10.2/29.9m	12.3			15.5	13.3			14.0	12.1			30.0
32.0		11.4			13.4	12.2			12.3	11.2			32.0
34.0		10.6			10.5	11.3			10.3	10.4			34.0
36.0		9.9			8.9/32.9m	10.5			7.8/35.8m	9.7			36.0
38.0		9.3	9.0/39.0m			9.8				9.1			38.0
40.0		8.7/40.0m	8.8			9.2				8.6			40.0
42.0			8.3			8.7	8.4/40.8m			8.1	7.8/42.5m		42.0
44.0			7.8			8.2	8.1			8.1	7.4		44.0
46.0			7.4			8.0/42.9m	7.6			7.6	7.0		46.0
48.0			7.0				7.2			7.1/45.8m	6.6		48.0
50.0			6.7/49.6m	4.6/51.7m			6.8				6.6		50.0
52.0				4.5			6.4				6.2		52.0
54.0				4.3			6.1	4.1/53.8m			5.9		54.0
56.0				4.1			6.0/52.6m	4.0			5.7		56.0
58.0				3.9				3.8			5.4/55.5m	3.5/56.0m	58.0
60.0				3.8/58.6m				3.6				3.3	60.0
62.0								3.4				2.9	62.0
64.0								3.2/61.6m				2.7	64.0
66.0												2.6/64.5m	66.0

タワー長さm	58.0									タワー長さm		
ジブ長さm	36.6				39.6			42.7			ジブ長さm	
タワー角度	90°	80°	70°	60°	90°	80°	70°	90°	80°	70°	タワー角度	
13.0	21.0/13.1m				19.3/13.9m						13.0	
14.0	20.8				19.3					17.7/14.7m	14.0	
15.0	20.6				19.1					17.5	15.0	
16.0	20.4				18.9					17.3	16.0	
18.0	20.0				18.5					16.9	18.0	
20.0	19.6				18.1					16.5	20.0	
22.0	19.2				17.7					16.1	22.0	
24.0	18.8				17.3					15.7	24.0	
26.0	18.3				16.9					15.3	26.0	
28.0	16.2	12.5/29.1m			16.5					14.9	28.0	
30.0	14.4	12.0			14.6	11.8/30.4m			14.5	11.4/31.7m	30.0	
32.0	12.8	11.1			13.0	11.0	11.1		13.1	10.9	32.0	
34.0	11.4	10.3			11.7	10.2			11.8	10.1	34.0	
36.0	10.0	9.6			10.5	9.5			10.6	9.4	36.0	
38.0	8.0	9.0			9.4	8.9			9.5	8.8	38.0	
40.0	6.9/38.8m	8.5			8.0	8.4			8.6	8.3	40.0	
42.0		8.0			6.1/41.7m	7.9			7.6	7.8	42.0	
44.0		7.5	7.1/44.3m			7.4			6.1	7.3	44.0	
46.0		7.1	6.8			7.0	6.6/46.0m		5.3/44.6m	6.9	6.3/47.8m	46.0
48.0		6.7	6.4			6.6	6.3			6.5	6.2	48.0
50.0		6.6/48.8m	6.0			6.3	5.9			6.2	5.8	50.0
52.0			5.7			6.1/51.7m	5.6			5.9	5.5	52.0
54.0			5.5				5.4			5.6	5.3	54.0
56.0			5.2				5.1			5.5/54.7m	5.0	56.0
58.0			4.9	3.1/58.1m			4.8				4.7	58.0
60.0			4.9/58.5m	2.9			4.6				4.5	60.0
62.0				2.7			4.5/61.4m				4.3	62.0
64.0				2.5							4.1	64.0
66.0				2.3							4.0/64.3m	66.0
68.0				2.2/67.5m								68.0

タワー長さm	58.0						タワー長さm
ジブ長さm	45.7			48.8			ジブ長さm
タワー角度	90°	80°	70°	90°	80°	70°	タワー角度
15.0	15.6/15.5m						15.0
16.0	15.5			13.8/16.3m			16.0
18.0	15.1			13.4			18.0
20.0	14.7			13.0			20.0
22.0	14.3			12.6			22.0
24.0	13.9			12.2			24.0
26.0	13.5			11.8			26.0
28.0	13.1			11.4			28.0
30.0	12.7			11.0			30.0
32.0	12.3	10.4/33.0m		10.6			32.0
34.0	11.9	10.0		10.2	9.8/34.3m		34.0
36.0	10.7	9.3		9.8	9.2		36.0
38.0	9.7	8.7		9.4	8.6		38.0
40.0	8.8	8.2		8.9	8.1		40.0
42.0	7.9	7.7		8.0	7.6		42.0
44.0	7.1	7.2		7.3	7.1		44.0
46.0	6.1	6.8		6.6	6.7		46.0
48.0	4.7/47.6m	6.4	5.8/49.5m	5.8	6.3		48.0
50.0		6.1	5.7	4.7	6.0	5.4/51.3m	50.0
52.0		5.8	5.4	4.1/50.5m	5.7	5.3	52.0
54.0		5.5	5.2		5.4	5.0	54.0
56.0		5.2	4.9		5.1	4.7	56.0
58.0		5.0/57.6m	4.6		4.9	4.4	58.0
60.0			4.4		4.6	4.2	60.0
62.0			4.2		4.6/60.6m	3.9	62.0
64.0			4.0			3.7	64.0
66.0			3.8			3.5	66.0
68.0			3.7/67.3m			3.3	68.0
70.0						3.1	70.0
72.0						3.1/70.2m	72.0

表中の太線で囲まれた部分は、ブーム等の強度によって定められた値です。

■分解時の寸法・質量

- 記載の数値は参考値です。
- 一般公道での輸送に際しては関係法規を遵守してください。

■本体

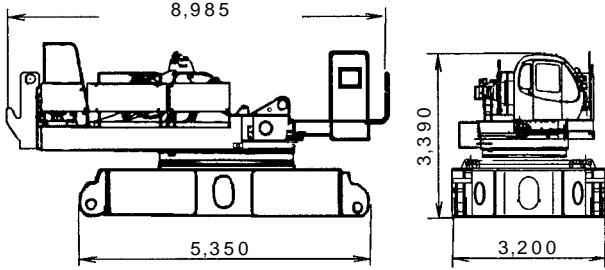
名称	寸法 (幅×高さ×長さ) mm	質量 (kg)
上部本体	3,200×3,425×11,590 カーボディ、ガントリ付 / 下部スプレッド、ブーム起伏ロープ、主巻ロープ無し	35,900
	3,200×3,400×8,985 カーボディ付 / ガントリ、ブーム起伏ロープ、主巻ロープ無し	33,400
	 カーボディ付 / ガントリ、ブーム起伏ロープ、主巻ドラム無し	31,500
クローラ	1,070×1,355×8,830	23,600
トランスリフタ	900×1,200	460
カウンタウエイトA	4,400×905×1,875	13,500
カウンタウエイトB	4,400×530×1,875	12,500
カウンタウエイトC	4,400×530×1,875	12,500
カウンタウエイトD	4,400×530×1,875	12,500
カウンタウエイトE	1,530×830×1,835	8,400
カウンタウエイトF	1,320×830×1,810	7,200
カーボディウエイト	2,400×945×1,380	10,000×2

■アタッチメント (ガイラインの質量は含まれていません)

名称	寸法 (幅×高さ×長さ) mm	質量 (kg)	名称	寸法 (幅×高さ×長さ) mm	質量 (kg)
下部ブーム	2,300×2,470×7,845	2,430	6.1m中間タワージブ	1,510×1,510×6,210	535
3.0m中間ブーム (共用)	2,275×2,125×3,175	610	9.1m中間タワージブ	1,510×1,510×9,260	755
6.1m中間ブーム (共用)	2,275×2,125×6,225	1,030	ガントリ	2,380×1,125×7,410	2,500
9.1m中間ブーム (共用)	2,275×2,125×9,270	1,450	タワーストラット	1,760×820×6,110	2,050
9.1m中間タワーブーム	2,275×2,125×9,270	1,750	上部スプレッド	2,350×335×885	635
ヘビイ上部ブーム	2,275×2,125×8,275	3,000	下部スプレッド	1,500×320×855	440
ライト上部ブーム	1,525×1,525×5,725	2,100	タワー用アッパスプレッド	1,020×245×765	240
5.4m中間テーパーブーム	2,275×2,125×5,570	840	タワー用口アスプレッド	2,275×690×835	460
タワー上部ジブ (ロング上部ブーム)	1,505×1,515×8,810	990	200tフック	995×2,225×700	2,800
タワーキャップ	2,340×2,295×5,545	2,100	150tフック	715×2,665×700	2,300
下部タワージブ	2,335×1,525×10,380	1,600	100tフック*	555×2,025×700	1,800
3.0m中継ジブ	1,510×1,510×3,150	320	65tフック	385×1,815×700	1,200
3.0m中間タワージブ	1,510×1,510×3,150	320	35tフック	365×1,575×700	900
			13.5tボールフック	380×1,200	450

* 150tフックと兼用です。

標準装備品

上下部本体	サンバイザ
102tウエイト 102.2t[13.5t+(12.5t×3)+(8.4t×2)+(7.2t×2)+(10t×2)]	天井ブラインド
67tウエイト 66.6t [13.5t+(12.5t×3)+8.4t+7.2t]	グリーンガラス
1070mm幅シュー	フロアマット(布製)
150AHバッテリー	フットレスト
トランスリフタ	靴置きトレイ
ガントリ起伏シリンダ(格納チェーン付)	安全装置
電動ハンドスロットル	過負荷防止装置(ブーム巻下緩停止機能付)
ブーム速度可変コントローラ	過負荷防止装置解除防止キー
主補速度可変コントローラ	過巻防止装置解除防止キー
旋回中立フリー/ブレーキ切替システム	カウンタウエイト検出装置
運転席サイドデッキ(手すり付)幅500mm×長さ2,590mm	液晶マルチディスプレイ
左ガード前面昇降ステップ	第2過巻防止装置(ブーム角度極限停止機能)
クローラ昇降ステップ×4	ブーム過巻自動停止装置(緩停止機能付)
アンチスリップシート(ガード上面、カウンタウエイト上面))	フック過巻自動停止装置
中間ブーム足場&ケーブルローラ	ブームバックストップ
上部スプレッド格納ガイド	乗降遮断式レバーロック
標準工具一式	走行レバーロック
工具箱(カーボディ部、左ガード内取付)	手動式ドラムバウルロック(主巻/補巻)
前照灯×2	手動式ドラムバウルロック(ブーム起伏)
バックミラー×2	ブームドラムバウル検出装置
ドラムミラー×2	中立時ネガブレーキ(主巻/補巻/ブーム起伏/走行)
ワンウェイコール	組立分解モードスイッチ
運転室	タワージブ格納緩停止機能
エアコン	旋回中立フリー/ブレーキ切替表示灯
ラゲッジトレイ	旋回中立フリー/ブレーキ切替スイッチ(ロック機構付)
カップキーパ	油圧安全弁(主巻/補巻/ブーム起伏/走行)
ラジオ(FM/AM)	ホーン
灰皿	旋回ブレーキ
シガーライター	旋回ロック(全周4ヶ所)
間欠式ワイパ&ウインドウォッシャー(天窓/前面/前面下窓)	旋回フラッシュ/ブザー

オプション装備品

トラベルキット	定格総荷重表示板: 下部ブーム腹面
カウンタウエイト吊り用ワイヤロープ	ブーム看板(上部ブーム用、中間ブーム用)
自立用敷板	差込式社名看板
リーピングウインチ: 8×260m	後方確認カメラ&モニタ(カラー)
油圧式タグライン: 10×45m	主/補ドラム監視カメラ&モニタ(カラー)
フットアクセル: case1-右側、case2-左右両側	ブームドラム監視カメラ&モニタ(カラー)
ブーム起伏ペダル: 右側	黄色回転灯
ドラム回転計/反力感知装置(主巻/補巻)	過負荷外部表示灯(角型3色灯)
水準器	警報付風速計(クレーン用、タワー用)
キャブ天井ガード	航空障害灯
キャブ前面ガード	マルチボイスアラーム: 過巻/過負荷
アンダーカバー(右デッキ)	外部音声アラーム: 走行/旋回
左側サイドキャットウォーク(手すり付): 幅610mm×長さ6,135mm	上部ブーム腹面保護材
ブーム背面全長足場(アルミ製)	電動式燃料給油ポンプ
ブーム上面脱着式手摺(スタンションバー)	消火器
ブームネスティング装置	扇風機
左ガード上面手すり	